

Belleta® iEA Series DC/DC Power Modules 48V Input, 25A Output Eighth Brick

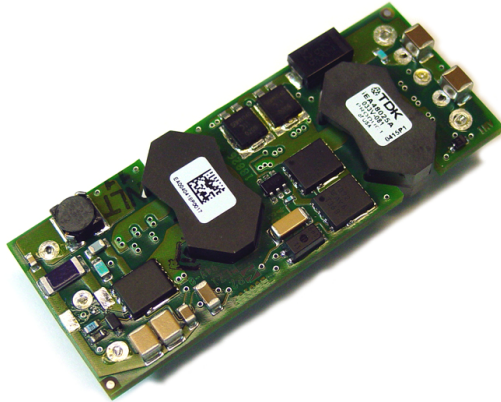

The Belleta Series offers an industry standard eighth brick power module with true useable power. Thanks to its low component count and single-board open-frame design, it provides both better electrical and thermal performance, and lower cost than many other suppliers' eighth brick product offerings. Belleta® modules are perfect for both next generation planning and cost reduction design environments

Standard Features:

- Size – 58.4mm x 22.9 mm x 8.8 mm (2.3 in. x 0.9 in. x 0.347 in.)
- Thru-hole pins 3.68 mm (0.145")
- High efficiency – greater than 89%
- 1500Vdc isolation voltage
- Meets basic insulation spacing requirements
- Constant switching frequency
- Industry Standard Footprint
- Output Voltage Adjustment
- Remote on/off (positive logic)
- Remote sense
- Auto-recovering output over-voltage protection
- Auto-recovering output over-current protection
- Auto-recovering output short circuit protection
- Auto-recovering over-temperature protection

- UL 60950 (US and Canada), VDE 0805, CB scheme (IEC950), CE Mark (EN60950)
- ISO Certified manufacturing facilities
- Patented Design

Optional Features:

- Remote on/off (negative logic)
- Latching output over-voltage protection
- Short Thru-hole pins 2.79 mm (0.110")
- Long Thru-hole pins 5.08 mm (0.200")

This page intentionally left blank

Mechanical Specification:

Dimensions are in mm [in]. Unless otherwise specified tolerances are: $x.x \pm 0.5$ [0.02], $x.xx$ and $x.xxx \pm 0.25$ [0.010].

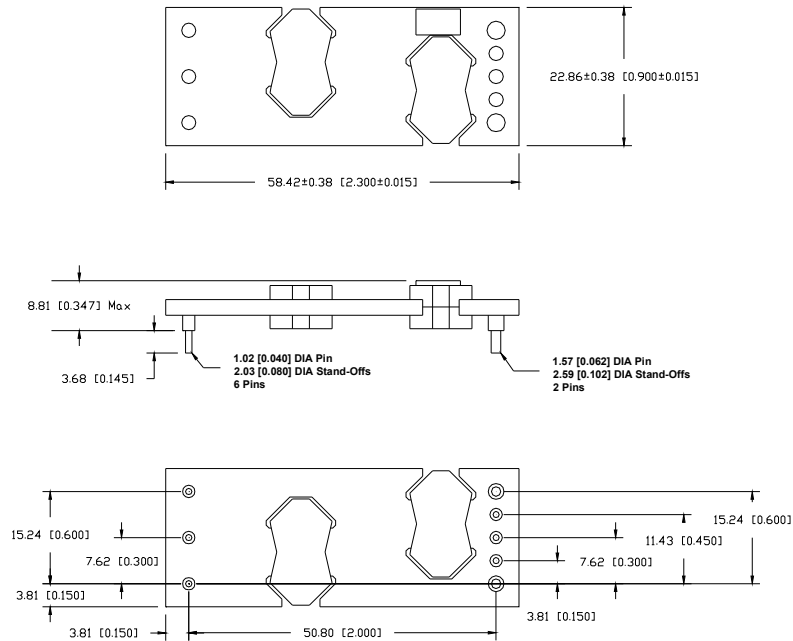

Recommended Hole Pattern: (top view)

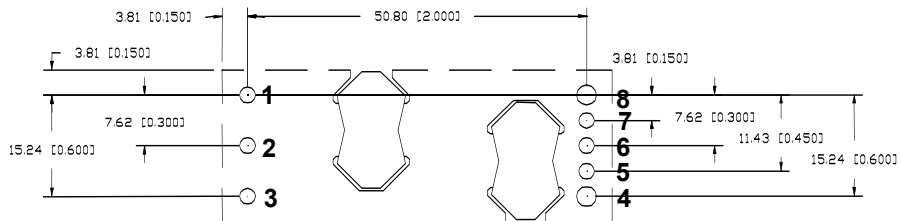

Pin Assignment:

PIN	FUNCTION	PIN	FUNCTION
1	Vin(+)	4	Vo(-)
2	On/Off	5	Sense(-)
3	Vin(-)	6	Trim
		7	Sense(+)
		8	Vo(+)

Pin base material is brass with tin plating; the maximum module weight is 30.4g (1.07 oz).

Data Sheet: Belleta® iEA Series –Single Output Eighth Brick

Absolute Maximum Ratings:

Stress in excess of Absolute Maximum Ratings may cause permanent damage to the device.

Characteristic	Min	Max	Unit	Notes & Conditions
Continuous Input Voltage	-0.5	80	Vdc	
Transient Input Voltage	---	100	Vdc	100mS max.
Isolation Voltage	---	1500	Vdc	
Storage Temperature	-55	125	°C	
Operating Temperature Range (Tc)	-40	125	°C	Measured at the location specified in the thermal measurement figure. Maximum temperature varies with model number, output current, and module orientation – see curve in thermal performance section of the data sheet.

Input Characteristics:

Unless otherwise specified, specifications apply over all Rated Input Voltage, Resistive Load, and Temperature conditions.

Characteristic	Min	Typ	Max	Unit	Notes & Conditions
Operating Input Voltage	36	48	75	Vdc	
Maximum Input Current	---	---	4	A	Vin = 0 to Vin,max
Turn-on Voltage	---	33	---	Vdc	
Turn-off Voltage	26	30	---	Vdc	
Hysteresis	0.5	3	---	Vdc	
Startup Delay Time from application of input voltage	---	35	---	mS	Vo = 0 to 0.1*Vo,nom; on/off =on, Io=Io,max, Tc=25°C
Startup Delay Time from on/off	---	35	---	mS	Vo = 0 to 0.1*Vo,nom; Vin = Vi,nom, Io=Io,max, Tc=25°C
Output Voltage Rise Time	---	50	---	mS	Io=Io,max, Tc=25°C, Vo=0.1 to 0.9*Vo,nom
Inrush Transient	---	---	0.2	A²s	
Input Reflected Ripple	---	15	---	mApp	See input/output ripple and noise measurements figure; BW = 20 MHz
Input Ripple Rejection	---	55	---	dB	@120Hz

Caution: The power modules are not internally fused. An external input line normal blow fuse with a maximum value of 10A is required, see the Safety Considerations section of the data sheet.

Data Sheet: Belleta® iEA Series –Single Output Eighth Brick

Electrical Data:

iEA48007A120V-000 through -015: 12V, 6.5A Output

Characteristic	Min	Typ	Max	Unit	Notes & Conditions
Output Voltage Initial Setpoint	11.64	12	12.36	Vdc	Vin=Vin,nom; Io=Io,max; Tc = 25°C
Output Voltage Tolerance	11.58	12	12.42	Vdc	Over all rated input voltage, load, and temperature conditions to end of life
Efficiency	---	90.5	---	%	Vin=Vin,nom; Io=Io,max; Tc = 25°C
Line Regulation	---	10	24	mV	Vin=Vin,min to Vin,max
Load Regulation	---	10	24	mV	Io=Io,min to Io,max
Temperature Regulation	---	60	240	mV	Tc=Tc,min to Tc,max
Output Current	0.5	---	6.5	A	At loads less than Io,min the module will continue to regulate the output voltage, but the output ripple may increase
Output Current Limiting Threshold	---	8.5	---	A	Vo = 0.9*Vo,nom, Tc<Tc,max
Short Circuit Current	---	12	---	A	Vo = 0.25V, Tc = 25°C
Output Ripple and Noise Voltage	---	80	200	mVpp	Measured across one 1.0 uF ceramic capacitor and a 10uF tantalum capacitor – see input/output ripple measurement figure; BW = 20MHz
	---	26	---	mVrms	
Output Voltage Adjustment Range	90	---	110	%Vo,nom	
Output Voltage Sense Range	---	---	10	%Vo,nom	
Dynamic Response: Recovery Time	---	60	---	uS	di/dt = 0.1A/uS, Vin=Vin,nom; load step from 50% to 75% of Io,max
Transient Voltage	---	220	---	mV	
Output Voltage Overshoot during startup	---	---	5	%	Vin=Vin,nom; Io=Io,max,Tc=25°C
Switching Frequency	---	400	---	kHz	Fixed
Output Over Voltage Protection	13.6	---	15.7	V	
External Load Capacitance	0	---	2000	uF	
Isolation Capacitance	---	1000	---	pF	
Isolation Resistance	10	---	---	MΩ	
Vref		1.225		V	Required for trim calculation

& Contact TDK Innoveta for applications that require additional capacitance or very low esr

Electrical Characteristics:
iEA48007A120V-000 through -015: 12V, 6.5A Output

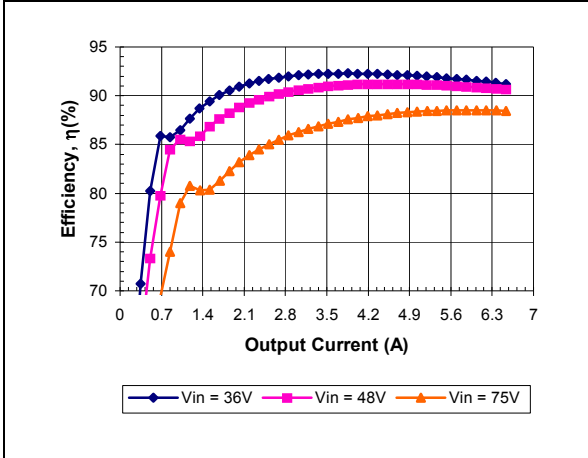

iEA48007A120V-000 Typical Efficiency vs. Input Voltage at Ta=25 degrees.

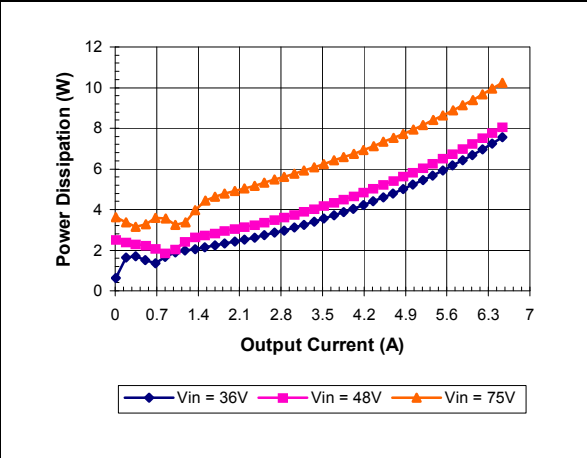

iEA48007A120V-000 Typical Power Dissipation vs. Input Voltage at Ta=25 degrees

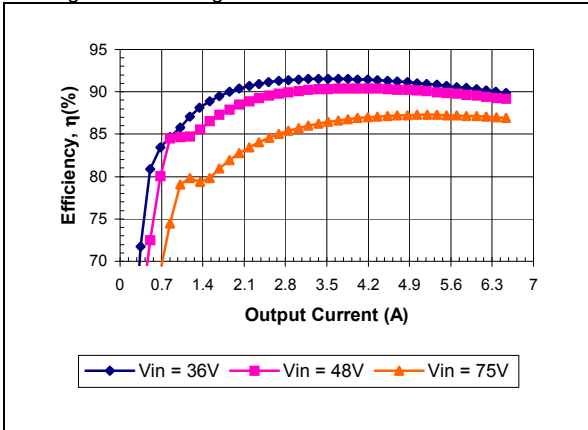

iEA48007A120V-000 Typical Efficiency vs. Input Voltage at Ta=85 degrees.

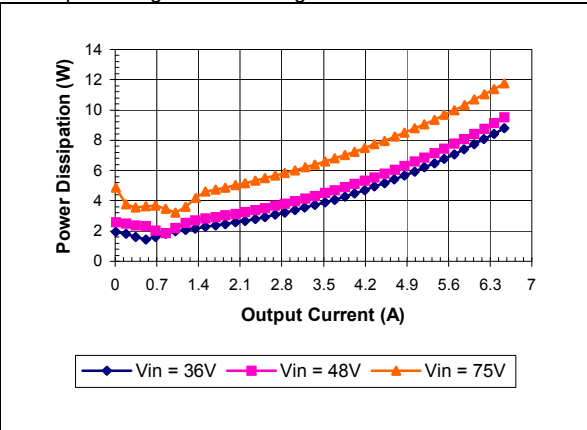

iEA48007A120V-000 Typical Power Dissipation vs. Input Voltage at Ta=85 degrees

Data Sheet: Belleta® iEA Series –Single Output Eighth Brick

Electrical Characteristics (continued): iEA48007A120V-000 through -015: 12V, 6.5A Output

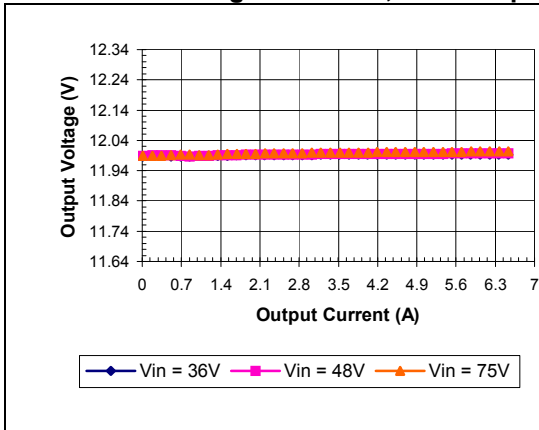

iEA48007A120V-000 Typical Output Voltage vs. Load Current at Ta = 25 degrees

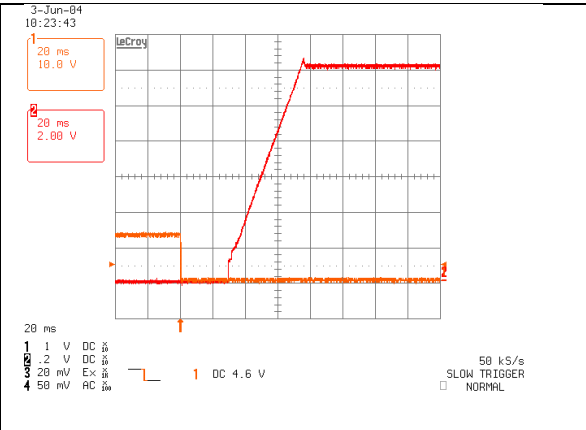

iEA48007A120V-001 Typical startup characteristic from on/off at full load. Ch 1 - on/off signal, Ch 2 – output voltage

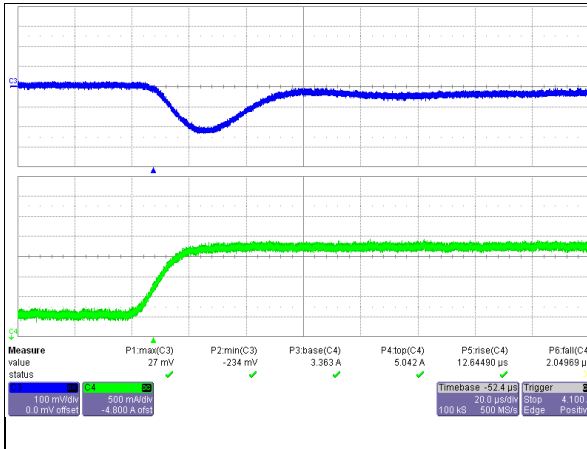

iEA48007A120V-000 Typical Output voltage response to load step from 50% to 75% of full load with output current slew rate of 0.1A/uS.

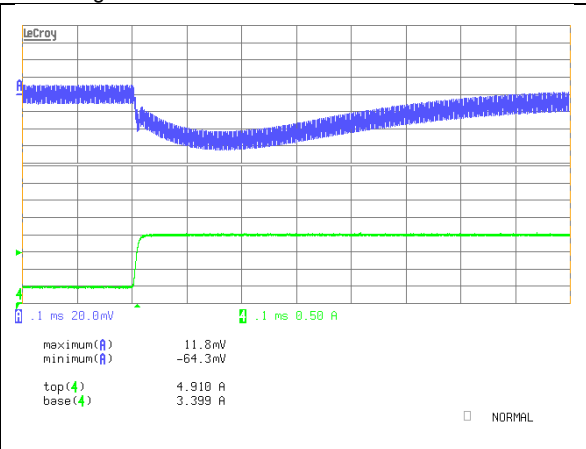

iEA48007A120V-000 Typical Output voltage response to load step from 50% to 75% of full load with output current slew rate of 0.1A/uS and 2200uF external load.

% Change of Vout	Trim Down Resistor (Kohm)	% Change of Vout	Trim Up Resistor (Kohm)
-5%	91.8K	+5%	937K
-10%	40.8K	+10%	488K

e.g. trim up 5%

$$R_{up} := \left[\frac{5.1 \times 12 \cdot (100 + 5)}{1.225 \times 5} - \frac{510}{5} - 10.2 \right] \cdot K$$

iEA48007A120V-000 Calculated resistor values for output voltage adjustment

Electrical Characteristics (continued):
iEA48007A120V-000 through -015: 12V, 6.5A Output

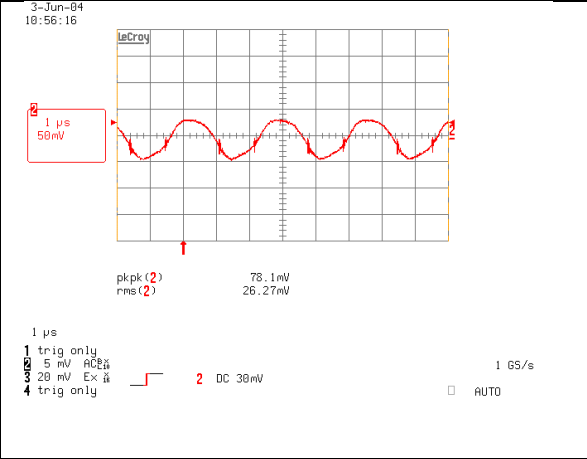
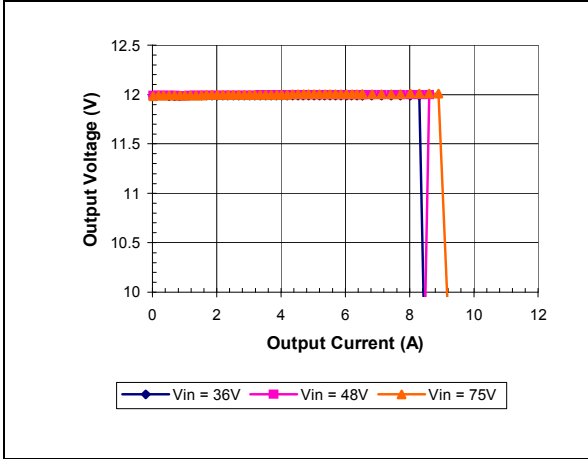

iEA48007A120V-000 Typical Output Current Limit Characteristics vs. Input Voltage at Ta=25 degrees.

iEA48007A120V-000 Typical Output Ripple at nominal input voltage and full load at Ta=25 degrees

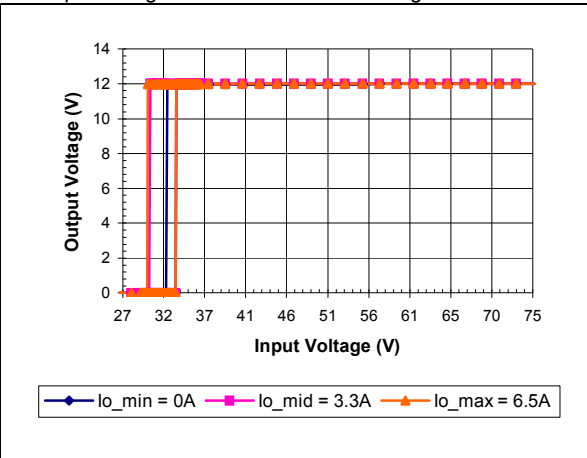
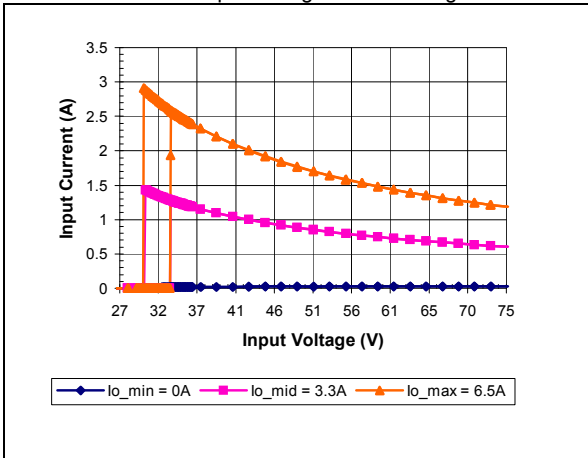

iEA48007A120V-000 Typical Input Current vs. Input Voltage Characteristics

iEA48007A120V-000 Typical Output Voltage vs. Input Voltage Characteristics

Thermal Performance:

iEA48007A120V-000 through -015: 12V, 6.5A Output

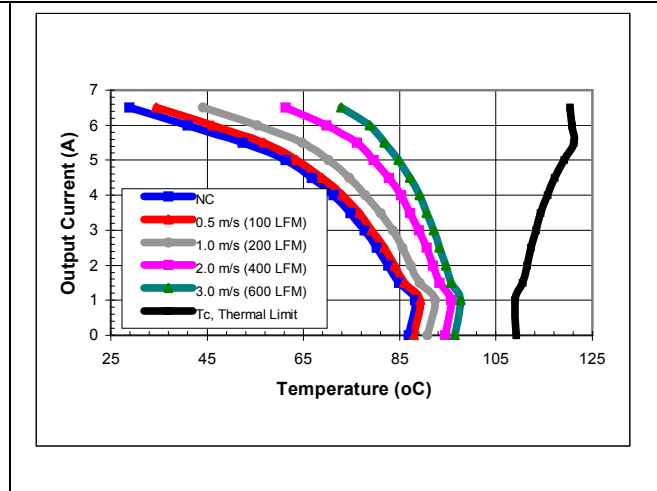
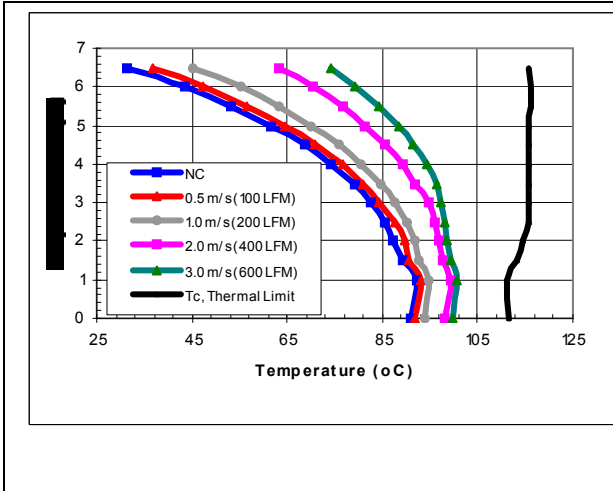

iEA48007A120V-000 maximum output current vs. ambient temperature at nominal input voltage for airflow rates natural convection (60lfm) to 600lfm with airflow from pin 3 to pin 1.

iEA48007A120V-000 maximum output current vs. ambient temperature at nominal input voltage for airflow rates natural convection (60lfm) to 600lfm with airflow from pin 1 to pin 3.

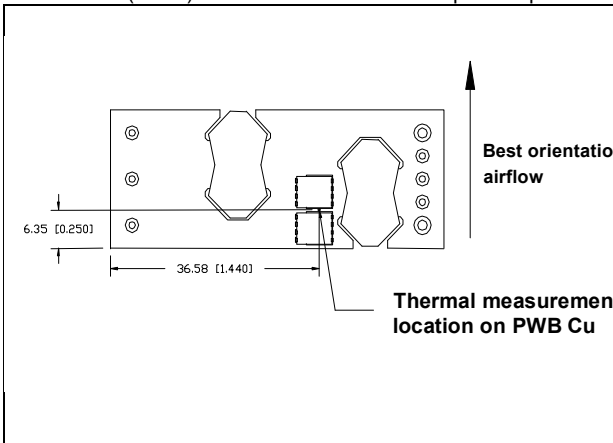

iEA48007A120V-000 thermal measurement location – top view

Both the thermal curves provided and the example given above are based upon measurements made in TDK Innoveta's experimental test setup that is described in the Thermal Management section. Due to the large number of variables in system design, TDK Innoveta recommends that the user verify the module's thermal performance in the end application. The critical component should be thermo coupled and monitored, and should not exceed the temperature limit specified in the derating curve above. It is critical that the thermocouple be mounted in a manner that gives direct thermal contact or significant measurement errors may result. TDK Innoveta can provide modules with a thermocouple pre-mounted to the critical component for system verification tests.

Electrical Data:

iEA48015A050V-000 through -015: 5V, 15A Output

Characteristic	Min	Typ	Max	Unit	Notes & Conditions
Output Voltage Initial Setpoint	4.92	5	5.08	Vdc	Vin=Vin,nom; Io=Io,max; Tc = 25°C
Output Voltage Tolerance	4.85	5	5.15	Vdc	Over all rated input voltage, load, and temperature conditions to end of life
Efficiency	---	90	---	%	Vin=Vin,nom; Io=Io,max; Tc = 25°C
Line Regulation	---	2	10	mV	Vin=Vin,min to Vin,max
Load Regulation	---	1	10	mV	Io=Io,min to Io,max
Temperature Regulation	---	30	75	mV	Tc=Tc,min to Tc,max
Output Current	1	---	15	A	At loads less than Io,min the module will continue to regulate the output voltage, but the output ripple may increase
Output Current Limiting Threshold	---	20	---	A	Vo = 0.9*Vo,nom, Tc<Tc,max
Short Circuit Current	---	14	---	A	Vo = 0.25V, Tc = 25°C
Output Ripple and Noise Voltage	---	55	125	mVpp	Measured across one 0.1 uF ceramic capacitor and a 22uF ceramic capacitor – see input/output ripple measurement figure; BW = 20MHz
	---	7	---	mVrms	
Output Voltage Adjustment Range	90	---	110	%Vo,nom	
Output Voltage Sense Range	---	---	10	%Vo,nom	
Dynamic Response: Recovery Time	---	100	---	uS	di/dt = 0.1A/uS, Vin=Vin,nom; load step from 50% to 75% of Io,max
Transient Voltage	---	200	---	mV	
Output Voltage Overshoot during startup	---	---	250	mV	Vin=Vin,nom; Io=Io,max, Tc=25°C
Switching Frequency	---	400	---	kHz	Fixed
Output Over Voltage Protection	5.7	---	6.7	V	
External Load Capacitance	0	---	5000	uF	
Isolation Capacitance	---	1000	---	pF	
Isolation Resistance	10	---	---	MΩ	
Vref		1.225		V	Required for trim calculation

& Contact TDK Innoveta for applications that require additional capacitance or very low esr

Electrical Characteristics:
iEA48015A050V-000 through -015: 5V, 15A Output

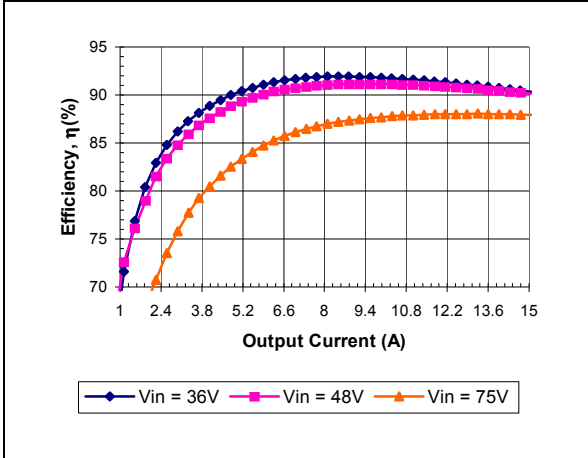

iEA48015A050V-000 Typical Efficiency vs. Input Voltage at Ta=25 degrees.

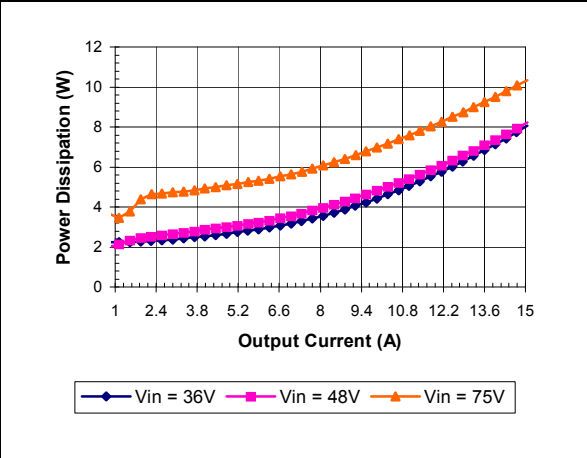

iEA48015A050V-000 Typical Power Dissipation vs. Input Voltage at Ta=25 degrees

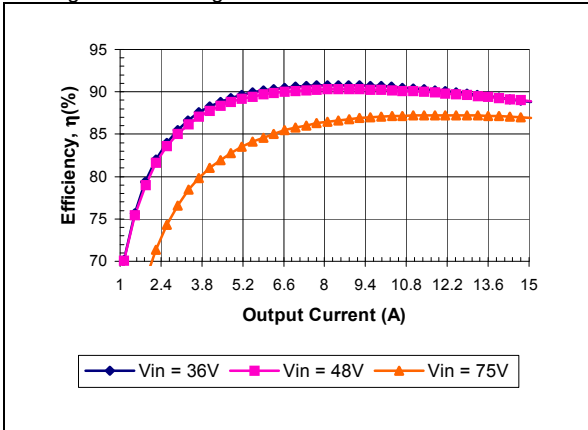

iEA48015A050V-000 Typical Efficiency vs. Input Voltage at Ta=85 degrees.

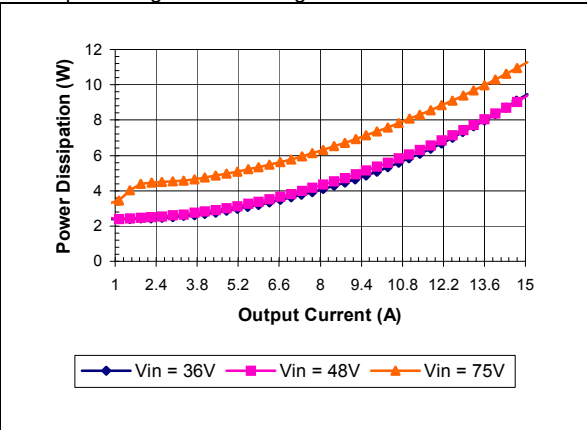

iEA48015A050V-000 Typical Power Dissipation vs. Input Voltage at Ta=85 degrees

Data Sheet: Belleta® iEA Series –Single Output Eighth Brick

Electrical Characteristics (continued): iEA48015A050V-000 through -015: 5V, 15A Output

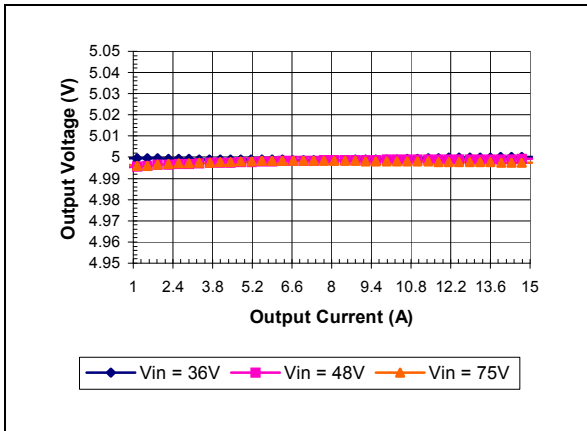

iEA48015A050V-000 Typical Output Voltage vs. Load Current at Ta = 25 degrees

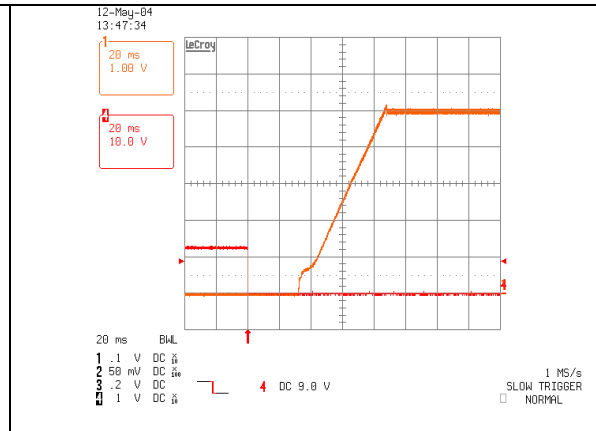

iEA48015A050V-001 Typical startup characteristic from on/off at full load. Ch4 - on/off signal, Ch 1 – output voltage

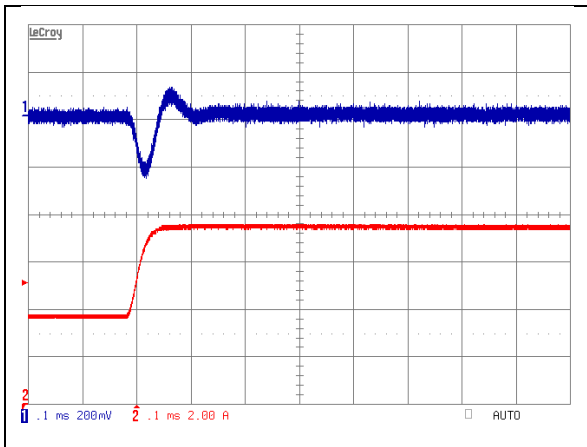

iEA48015A050V-000 Typical Output voltage response to load step from 50% to 75% of full load with output current slew rate of 0.1A/uS.

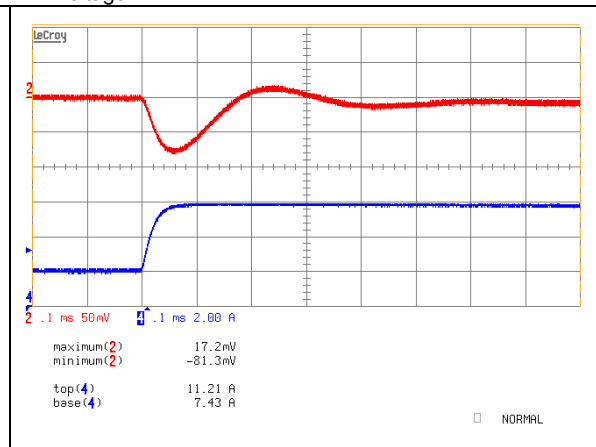

iEA48015A050V-000 Typical Output voltage response to load step from 50% to 75% of full load with output current slew rate of 0.1A/uS and 5000uF load.

% Change of Vout	Trim Down Resistor (Kohm)	% Change of Vout	Trim Up Resistor (Kohm)
-5%	91.8K	+5%	325K
-10%	40.8K	+10%	168K

e.g. trim up 5%

$$R_{up} := \left[\frac{5.1 \times 5 \cdot (100 + 5)}{1.225 \times 5} - \frac{510}{5} - 10.2 \right] \cdot K$$

iEA48015A050V-000 Calculated resistor values for output voltage adjustment

Electrical Characteristics (continued):
iEA48015A050V-000 through -015: 5V, 15A Output

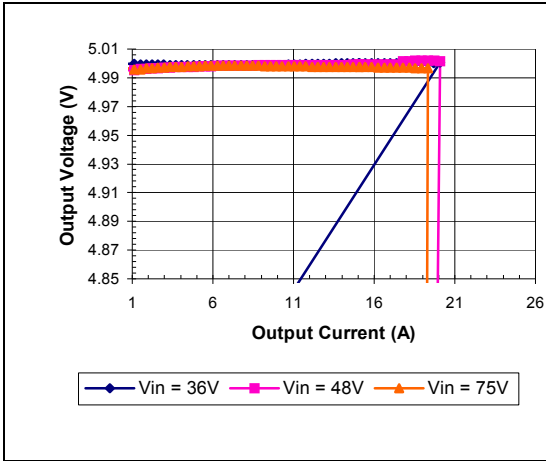

iEA48015A050V-000 Typical Output Current Limit Characteristics vs. Input Voltage at Ta=25 degrees.

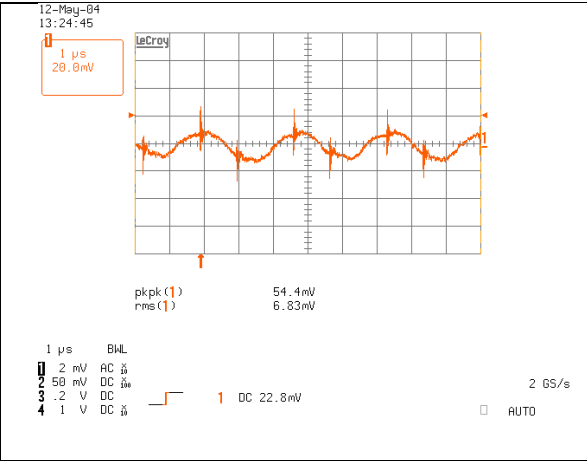

iEA48015A050V-000 Typical Output Ripple at nominal input voltage and full load at Ta=25 degrees

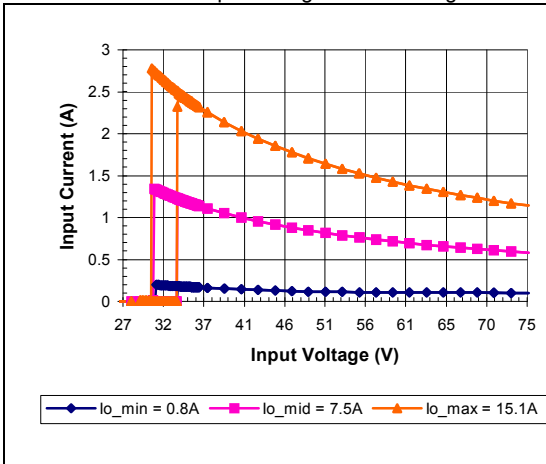

iEA48015A050V-000 Typical Input Current vs. Input Voltage Characteristics

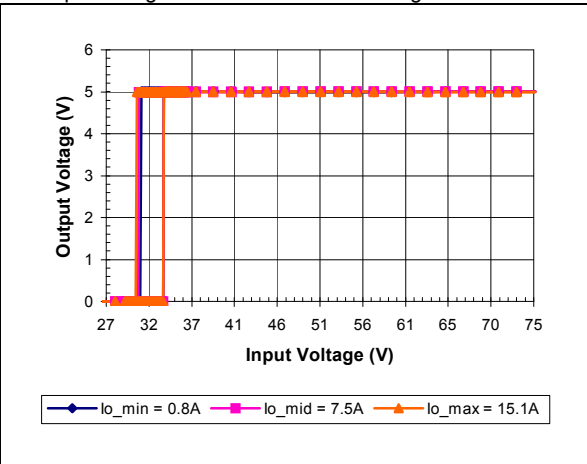

iEA48015A050V-000 Typical Output Voltage vs. Input Voltage Characteristics

Thermal Performance:

iEA48015A050V-000 through -015: 5V, 15A Output

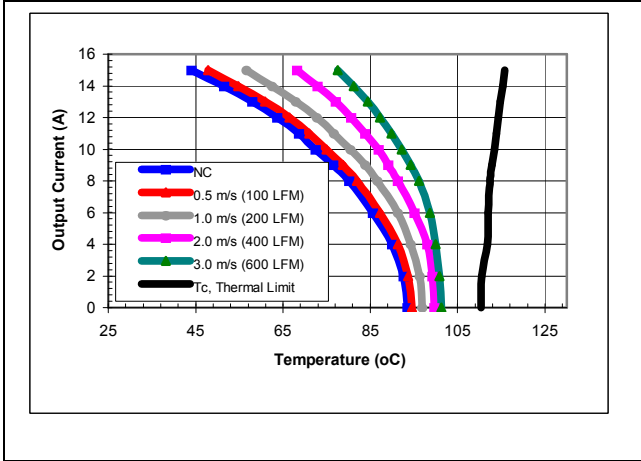

iEA48015A050V-000 maximum output current vs. ambient temperature at nominal input voltage for airflow rates natural convection (60lfm) to 600lfm with airflow from pin 3 to pin 1.

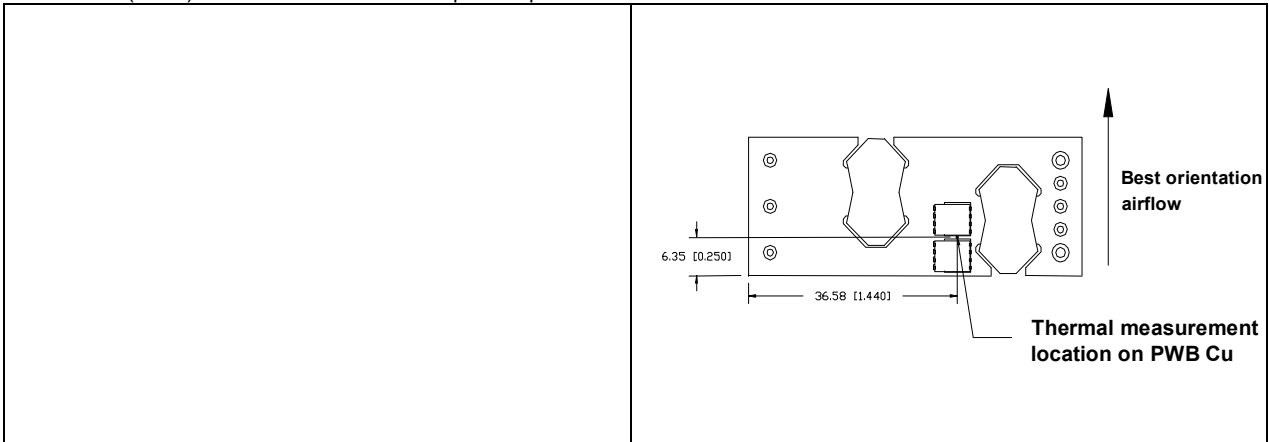

iEA48015A050V-000 thermal measurement location – top view

Both the thermal curves provided and the example given above are based upon measurements made in TDK Innoveta's experimental test setup that is described in the Thermal Management section. Due to the large number of variables in system design, TDK Innoveta recommends that the user verify the module's thermal performance in the end application. The critical component should be thermo coupled and monitored, and should not exceed the temperature limit specified in the derating curve above. It is critical that the thermocouple be mounted in a manner that gives direct thermal contact or significant measurement errors may result. TDK Innoveta can provide modules with a thermocouple pre-mounted to the critical component for system verification tests.

Data Sheet: Belleta[®] iEA Series –Single Output Eighth Brick

Electrical Data:

iEA48020A033V-000 through -015: 3.3V, 20A Output

Characteristic	Min	Typ	Max	Unit	Notes & Conditions
Output Voltage Initial Setpoint	3.25	3.3	3.35	Vdc	Vin=Vin,nom; Io=Io,max; Tc = 25°C
Output Voltage Tolerance	3.20	3.3	3.40	Vdc	Over all rated input voltage, load, and temperature conditions to end of life
Efficiency	---	89.5	---	%	Vin=Vin,nom; Io=Io,max; Tc = 25°C
Line Regulation	---	2	7	mV	Vin=Vin,min to Vin,max
Load Regulation	---	3	8	mV	Io=Io,min to Io,max
Temperature Regulation	---	15	60	mV	Tc=Tc,min to Tc,max
Output Current	1.5	---	20	A	At loads less than Io,min the module will continue to regulate the output voltage, but the output ripple may increase
Output Current Limiting Threshold	---	29	---	A	Vo = 0.9*Vo,nom, Tc<Tc,max
Short Circuit Current	---	20	---	A	Vo = 0.25V, Tc = 25°C
Output Ripple and Noise Voltage	---	35	100	mVpp	Measured across one 1.0 uF ceramic capacitor and a 10uF tantalum capacitor – see input/output ripple measurement figure; BW = 20MHz
	---	11	---	mVrms	
Output Voltage Adjustment Range	90	---	110	%Vo,nom	The trim range is reduced to 105% when the input voltage is below 40V.
Output Voltage Sense Range	---	---	10	%Vo,nom	The sense range is reduced to 5% when the input voltage is below 40V.
Dynamic Response: Recovery Time	---	90	---	uS	di/dt = 0.1A/uS, Vin=Vin,nom; load step from 50% to 75% of Io,max
Transient Voltage	---	180	---	mV	
Output Voltage Overshoot during startup	---	---	165	mV	Vin=Vin,nom; Io=Io,max, Tc=25°C
Switching Frequency	---	400	---	kHz	Fixed
Output Over Voltage Protection	3.75	---	4.4	V	
External Load Capacitance	100	---	5000&	uF	Recommend TDK part C3225X5R0J107MT
Isolation Capacitance	---	1000	---	pF	
Isolation Resistance	10	---	---	MΩ	
Vref		1.225		V	Required for trim calculation

& Contact TDK Innoveta for applications that require additional capacitance or very low esr

Electrical Characteristics:
iEA48020A033V-000 through -015: 3.3V, 20A Output

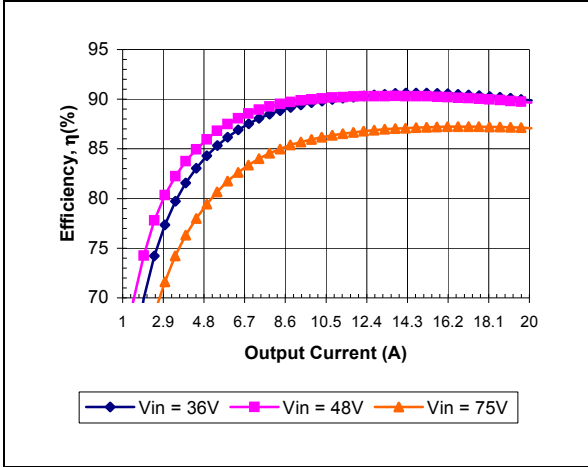

iEA48020A033V-000 Typical Efficiency vs. Input Voltage at Ta=25 degrees.

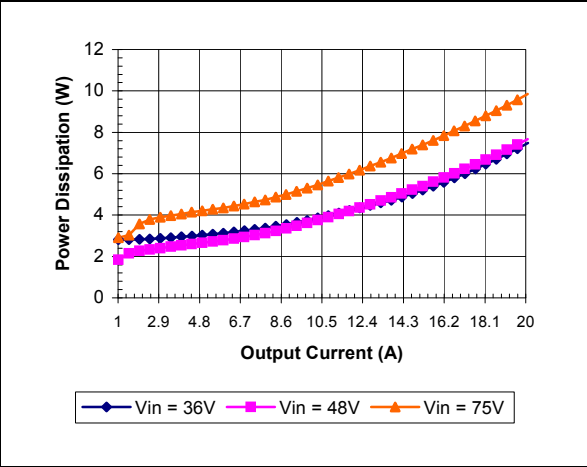

iEA48020A033V-000 Typical Power Dissipation vs. Input Voltage at Ta=25 degrees

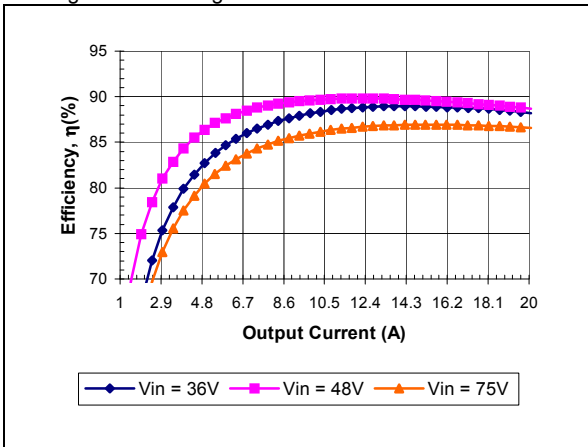

iEA48020A033V-000 Typical Efficiency vs. Input Voltage at Ta=85 degrees.

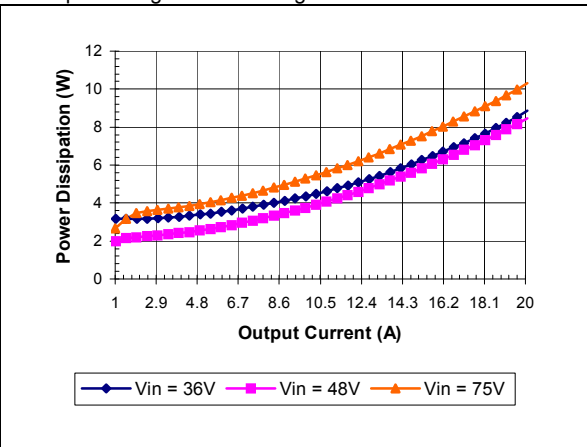

iEA48020A033V-000 Typical Power Dissipation vs. Input Voltage at Ta=85 degrees

Data Sheet: Belleta® iEA Series –Single Output Eighth Brick

Electrical Characteristics (continued): iEA48020A033V-000 through -015: 3.3V, 20A Output

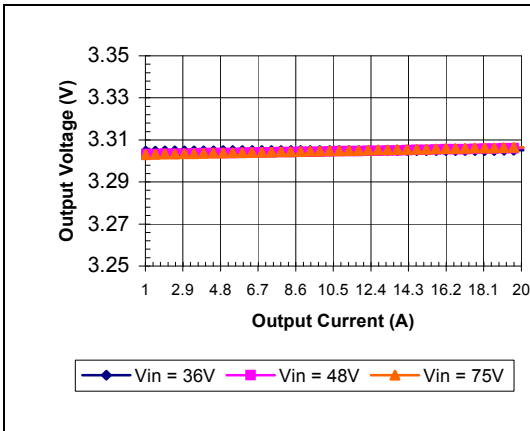

iEA48020A033V-000 Typical Output Voltage vs. Load Current at Ta = 25 degrees

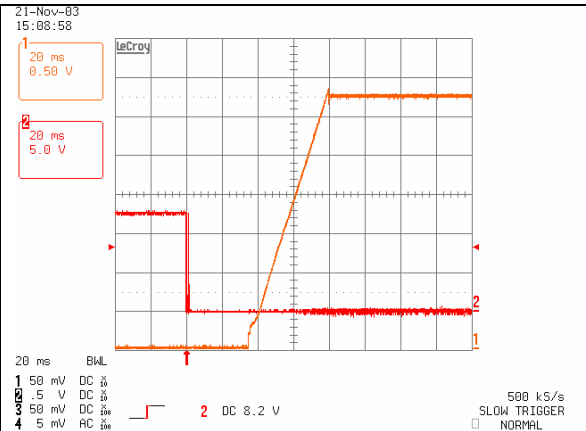

iEA48020A033V-001 Typical startup characteristic from on/off at full load. Ch2 - on/off signal, Ch 1 – output voltage

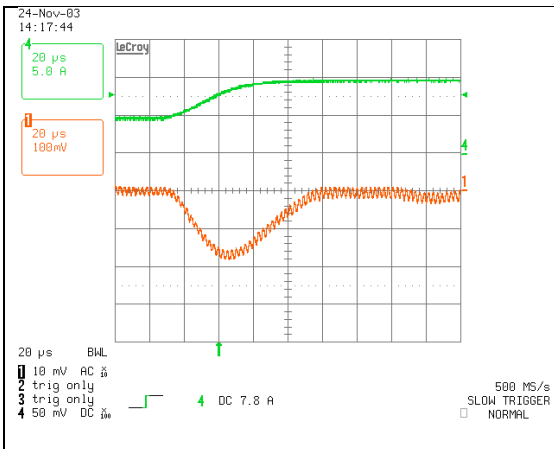

iEA48020A033V-000 Typical output voltage response to load step from 50% to 75% of full load with output current slew rate of 0.1A/uS.

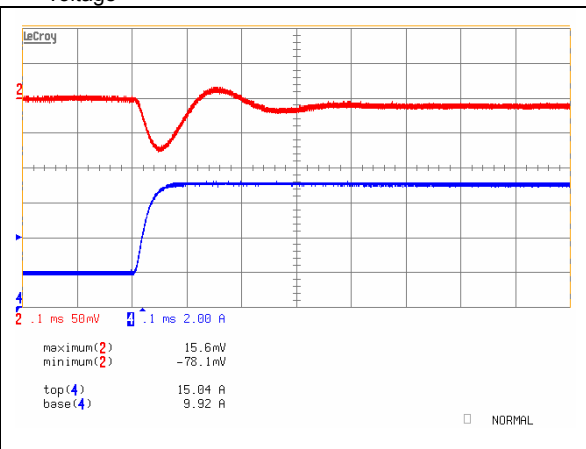

iEA48020A033V-000 Typical output voltage response to load step from 50% to 75% of full load with output current slew rate of 0.1A/uS and 5000uF load.

% Change of Vout	Trim Down Resistor (Kohm)	% Change of Vout	Trim Up Resistor (Kohm)
-5%	91.8K	+5%	176.3K
-10%	40.8K	+10%	89.9K

e.g. trim up 5%

$$R_{up} := \left[\frac{5.1 \times 3.3 \cdot (100 + 5)}{1.225 \times 5} - \frac{510}{5} - 10.2 \right] \cdot K$$

iEA48020A033V-000 Calculated resistor values for output voltage adjustment

Electrical Characteristics (continued):
iEA48020A033V-000 through -015: 3.3V, 20A Output

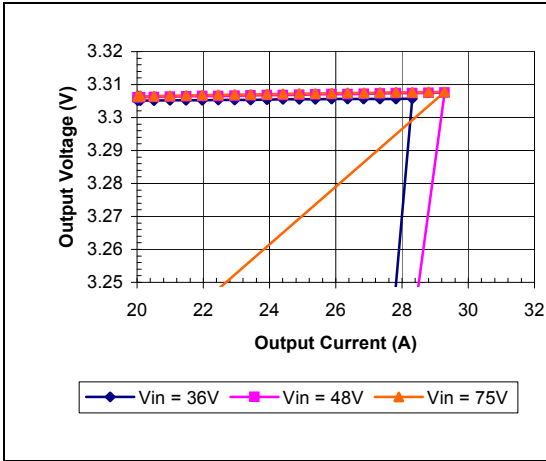

iEA48020A033V-000 Typical Output Current Limit Characteristics vs. Input Voltage at Ta=25 degrees.

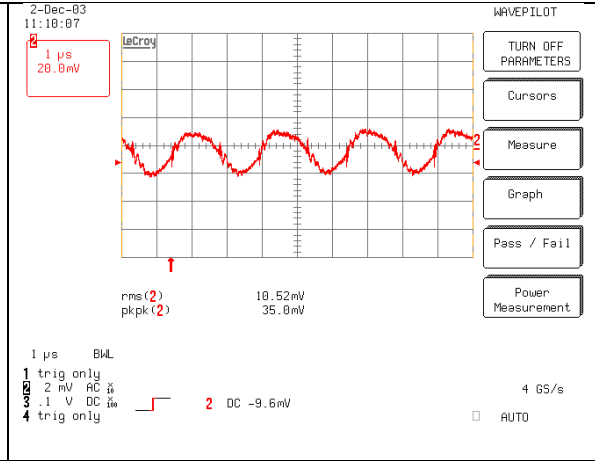

iEA48020A033V-000 Typical Output Ripple at nominal input voltage and full load at Ta=25 degrees

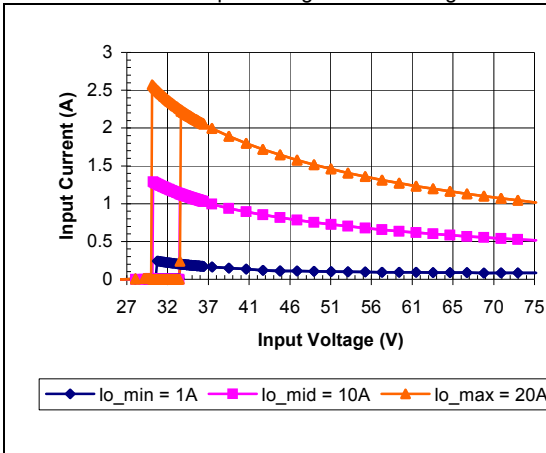

iEA48020A033V-000 Typical Input Current vs. Input Voltage Characteristics

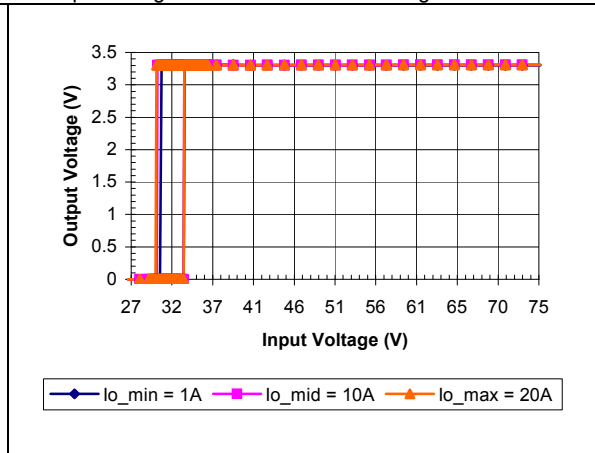

iEA48020A033V-000 Typical Output Voltage vs. Input Voltage Characteristics

Data Sheet: Belleta® iEA Series –Single Output Eighth Brick

Thermal Performance:

iEA48020A033V-000 through -015: 3.3V, 20A Output

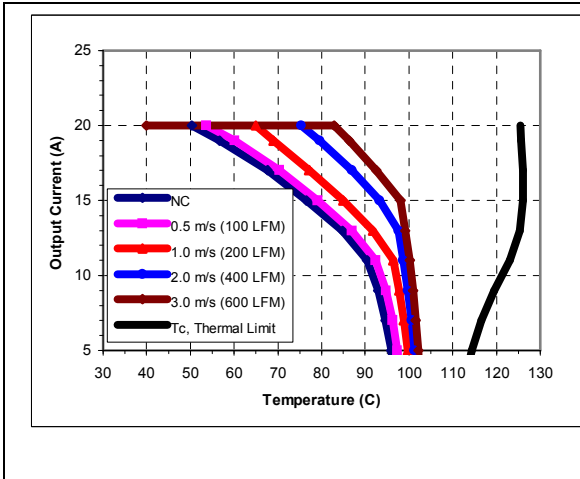

iEA48020A033V-000 maximum output current vs. ambient temperature at nominal input voltage for airflow rates natural convection (60lfm) to 600lfm with airflow from pin 3 to pin 1.

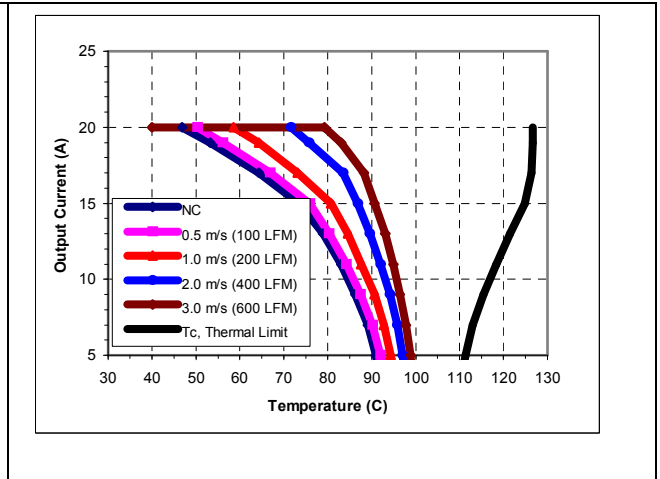

iEA48020A033V-000 maximum output current vs. ambient temperature at nominal input voltage for airflow rates natural convection (60lfm) to 600lfm with airflow from pin 1 to pin 3.

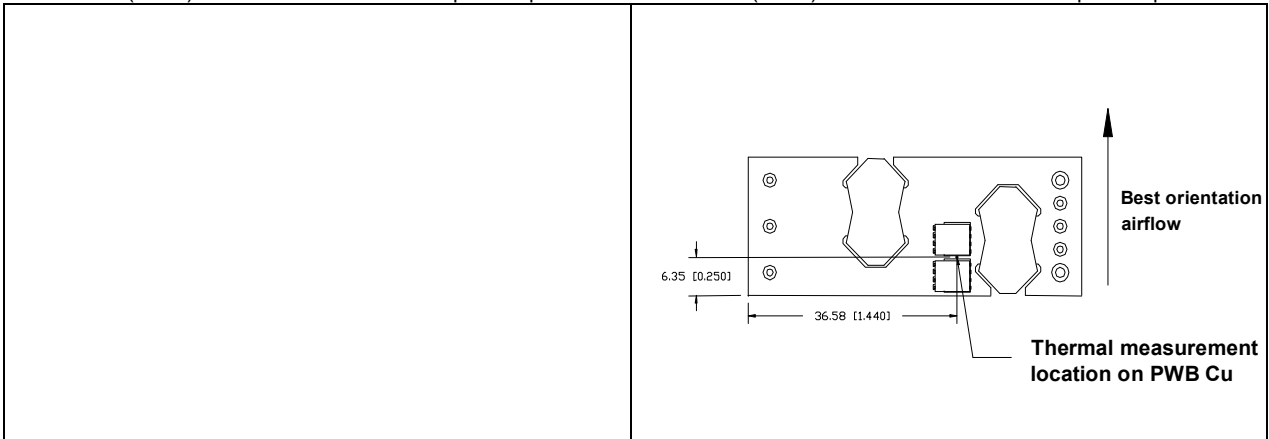

iEA48020A033V-000 thermal measurement location – top view

Both the thermal curves provided and the example given above are based upon measurements made in TDK Innoveta's experimental test setup that is described in the Thermal Management section. Due to the large number of variables in system design, TDK Innoveta recommends that the user verify the module's thermal performance in the end application. The critical component should be thermo coupled and monitored, and should not exceed the temperature limit specified in the derating curve above. It is critical that the thermocouple be mounted in a manner that gives direct thermal contact or significant measurement errors may result. TDK Innoveta can provide modules with a thermocouple pre-mounted to the critical component for system verification tests.

Data Sheet: Belleta® iEA Series –Single Output Eighth Brick

Electrical Data:

iEA48025A025V-000 through -015: 2.5V, 25A Output

Characteristic	Min	Typ	Max	Unit	Notes & Conditions
Output Voltage Initial Setpoint	2.46	2.5	2.54	Vdc	Vin=Vin,nom; Io=Io,max; Tc = 25°C
Output Voltage Tolerance	2.42	2.5	2.58	Vdc	Over all rated input voltage, load, and temperature conditions to end of life
Efficiency	---	85.5	---	%	Vin=Vin,nom; Io=Io,max; Tc = 25°C
Line Regulation	---	1	5	mV	Vin=Vin,min to Vin,max
Load Regulation	---	1	7	mV	Io=Io,min to Io,max
Temperature Regulation	---	10	50	mV	Tc=Tc,min to Tc,max
Output Current	2.0	---	25	A	At loads less than Io,min the module will continue to regulate the output voltage, but the output ripple may increase
Output Current Limiting Threshold	---	31	---	A	Vo = 0.9*Vo,nom, Tc<Tc,max
Short Circuit Current	---	20	---	A	Vo = 0.25V, Tc = 25°C
Output Ripple and Noise Voltage	---	35	100	mVpp	Measured across one 1.0 uF ceramic capacitor and a 10uF tantalum capacitor – see input/output ripple measurement figure; BW = 20MHz
	---	11	---	mVrms	
Output Voltage Adjustment Range	90	---	110	%Vo,nom	
Output Voltage Sense Range	---	---	10	%Vo,nom	
Dynamic Response: Recovery Time	---	100*	---	uS	di/dt = 0.1A/uS, Vin=Vin,nom; load step from 50% to 75% of Io,max
Transient Voltage	---	200*	---	mV	
Output Voltage Overshoot during startup	---	---	165	mV	Vin=Vin,nom; Io=Io,max, Tc=25°C
Switching Frequency	---	400	---	KHz	Fixed
Output Over Voltage Protection	2.7	---	3.5	V	
External Load Capacitance	0	---	5000	uF	
Isolation Capacitance	---	1000	---	pF	
Isolation Resistance	10	---	---	MΩ	
Vref		1.225		V	Required for trim calculation

& Contact TDK Innoveta for applications that require additional capacitance or very low esr

Electrical Characteristics: iEA48025A025V-000 through -015: 2.5V, 25A Output

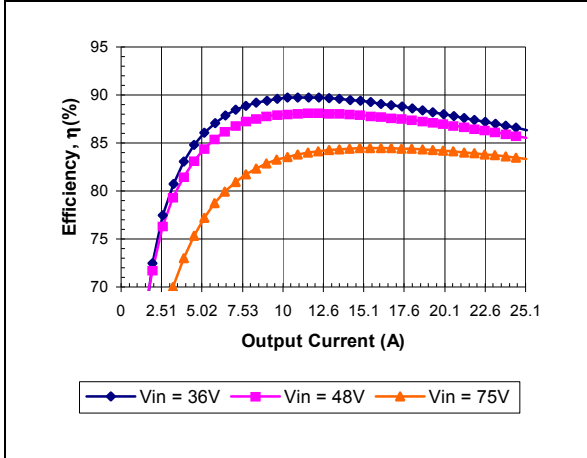

iEA48025A025V-000 Typical Efficiency vs. Input Voltage at Ta=25 degrees.

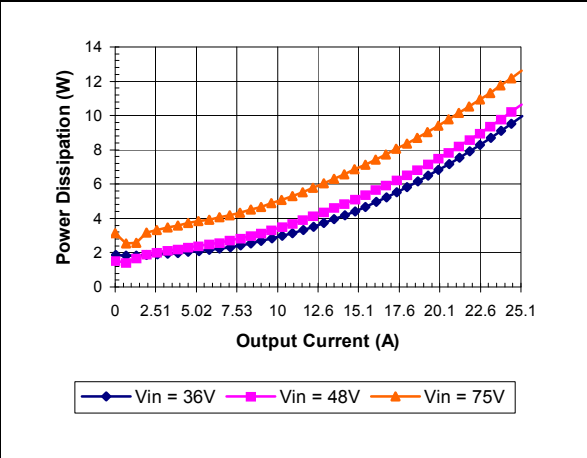

iEA48025A025V-000 Typical Power Dissipation vs. Input Voltage at Ta=25 degrees

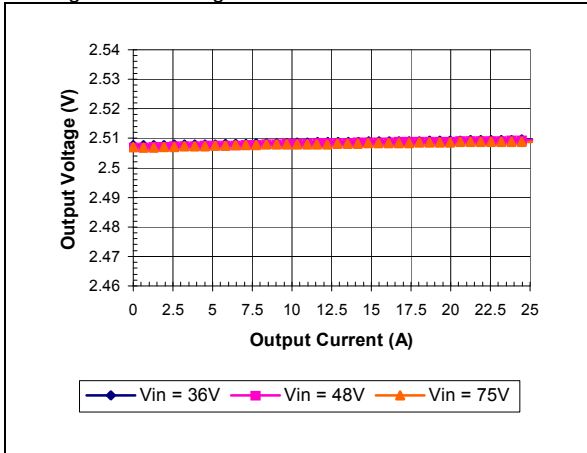

iEA48025A025V-000 Typical Output Voltage vs. Load Current at Ta = 25 degrees

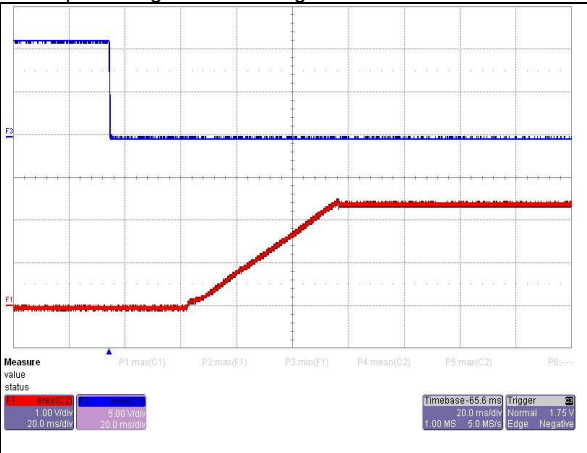

iEA48025A025V-001 Typical startup characteristic from on/off at full load. Ch3 - on/off signal, Ch 1 – output voltage

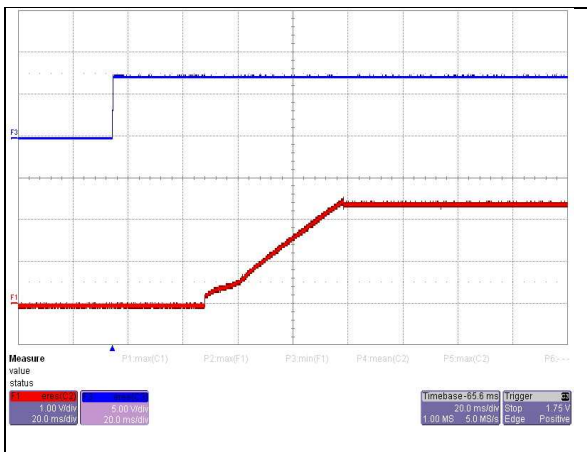

iEA48025A025V-000 Typical startup characteristic from input voltage application at full load. Ch3 - input voltage, Ch 1 – output voltage

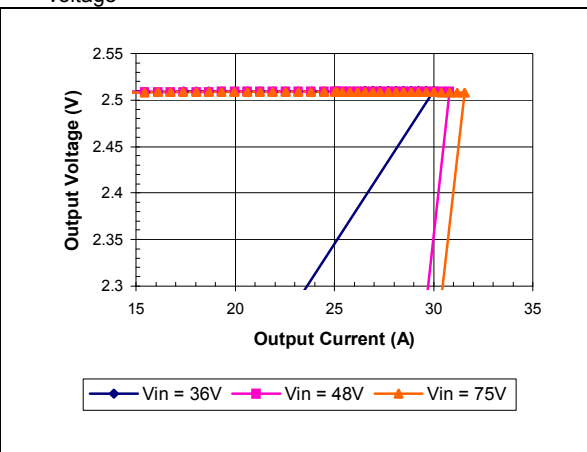

iEA48025A025V-000 Typical Output Current Limit Characteristics vs. Input Voltage at Ta=25 degrees.

Electrical Characteristics (continued):
iEA48025A025V-000 through -015: 2.5V, 25A Output

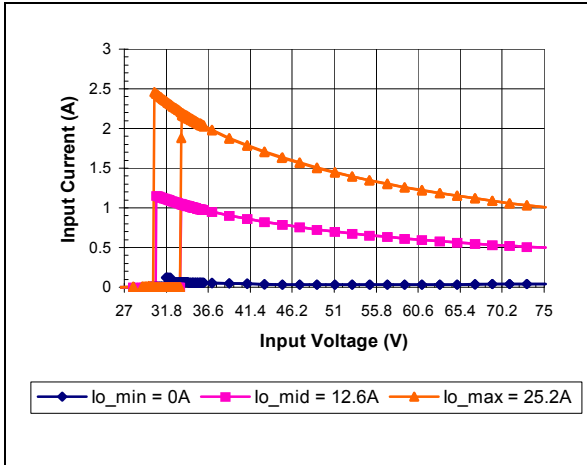

iEA48025A025V-000 Typical Input Current vs. Input Voltage Characteristics

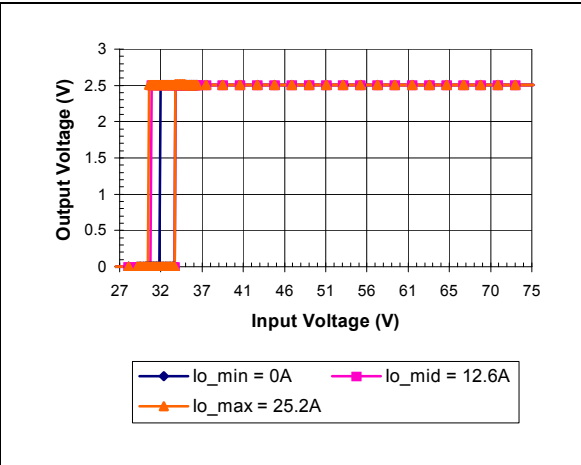

iEA48025A025V-000 Typical Output Voltage vs. Input Voltage Characteristics

% Change of Vout	Trim Down Resistor (Kohm)	% Change of Vout	Trim Up Resistor (Kohm)
-5%	91.8K	+5%	106K
-10%	40.8K	+10%	53.3K

e.g. trim up 5%

$$R_{up} := \left[\frac{5.1 \times 2.5 \cdot (100 + 5)}{1.225 \times 5} - \frac{510}{5} - 10.2 \right] \cdot K$$

iEA48025A025V-000 Calculated resistor values for output voltage adjustment

Thermal Performance:

iEA48025A025V-000 through -015: 2.5V, 25A Output

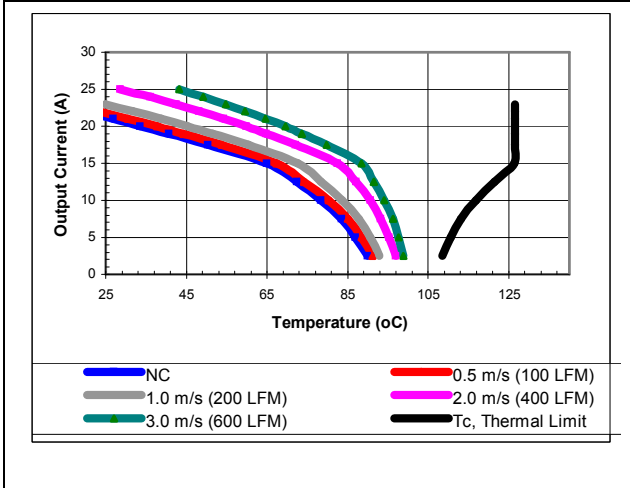

iEA48025A025V-000 maximum output current vs. ambient temperature at nominal input voltage for airflow rates natural convection (60lfm) to 600lfm with airflow from pin 3 to pin 1.

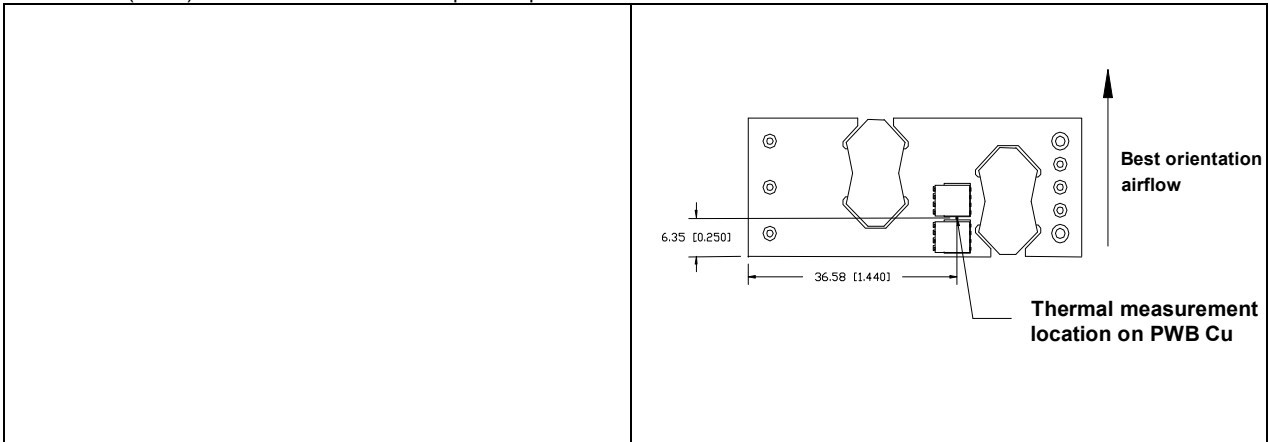

iEA48025A025V-000 thermal measurement location – top view

Both the thermal curves provided and the example given above are based upon measurements made in TDK Innoveta's experimental test setup that is described in the Thermal Management section. Due to the large number of variables in system design, TDK Innoveta recommends that the user verify the module's thermal performance in the end application. The critical component should be thermo coupled and monitored, and should not exceed the temperature limit specified in the derating curve above. It is critical that the thermocouple be mounted in a manner that gives direct thermal contact or significant measurement errors may result. TDK Innoveta can provide modules with a thermocouple pre-mounted to the critical component for system verification tests.

Electrical Data:

iEA48025A018V-000 through -015: 1.8V, 25A Output

Characteristic	Min	Typ	Max	Unit	Notes & Conditions
Output Voltage Initial Setpoint	1.77	1.8	1.83	Vdc	Vin=Vin,nom; Io=Io,max; Tc = 25°C
Output Voltage Tolerance	1.74	1.8	1.86	Vdc	Over all rated input voltage, load, and temperature conditions to end of life
Efficiency	---	82.5	---	%	Vin=Vin,nom; Io=Io,max; Tc = 25°C
Line Regulation	---	1	5	mV	Vin=Vin,min to Vin,max
Load Regulation	---	1	7	mV	Io=Io,min to Io,max
Temperature Regulation	---	10	50	mV	Tc=Tc,min to Tc,max
Output Current	2.0	---	25	A	At loads less than Io,min the module will continue to regulate the output voltage, but the output ripple may increase
Output Current Limiting Threshold	---	35	---	A	Vo = 0.9*Vo,nom, Tc<Tc,max
Short Circuit Current	---	20	---	A	Vo = 0.25V, Tc = 25°C
Output Ripple and Noise Voltage	---	35	100	mVpp	Measured across one 1.0 uF ceramic capacitor and a 10uF tantalum capacitor – see input/output ripple measurement figure; BW = 20MHz
	---	8	---	mVrms	
Output Voltage Adjustment Range	90	---	110	%Vo,nom	
Output Voltage Sense Range	---	---	10	%Vo,nom	
Dynamic Response: Recovery Time	---	120	---	uS	di/dt = 0.1A/uS, Vin=Vin,nom; load step from 50% to 75% of Io,max
Transient Voltage	---	130	---	mV	
Output Voltage Overshoot during startup	---	---	165	mV	Vin=Vin,nom; Io=Io,max, Tc=25°C
Switching Frequency	---	400	---	kHz	Fixed
Output Over Voltage Protection	2.12	---	2.58	V	
External Load Capacitance	0	---	5000	uF	
Isolation Capacitance	---	1000	---	pF	
Isolation Resistance	10	---	---	MΩ	
Vref		1.225		V	Required for trim calculation

& Contact TDK Innoveta for applications that require additional capacitance or very low esr

Electrical Characteristics:
iEA48025A018V-000 through -015: 1.8V, 25A Output

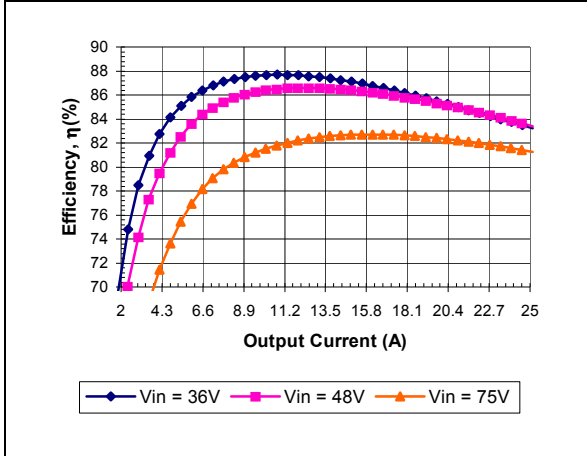

iEA48025A018V-000 Typical Efficiency vs. Input Voltage at Ta=25 degrees.

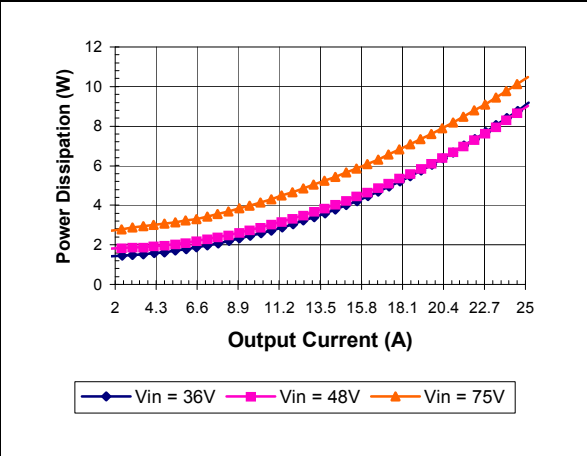

iEA48025A018V-000 Typical Power Dissipation vs. Input Voltage at Ta=25 degrees

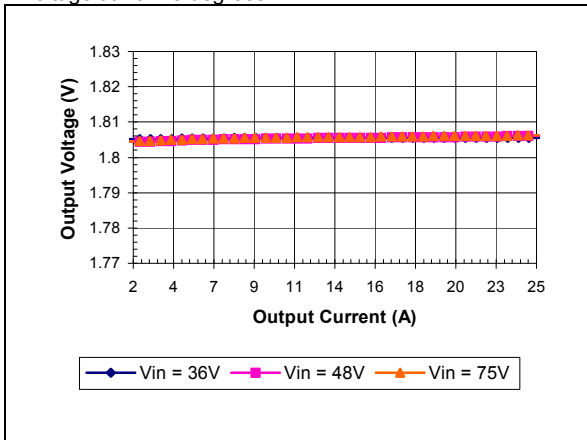

iEA48025A018V-000 Typical Output Voltage vs. Load Current at Ta = 25 degrees

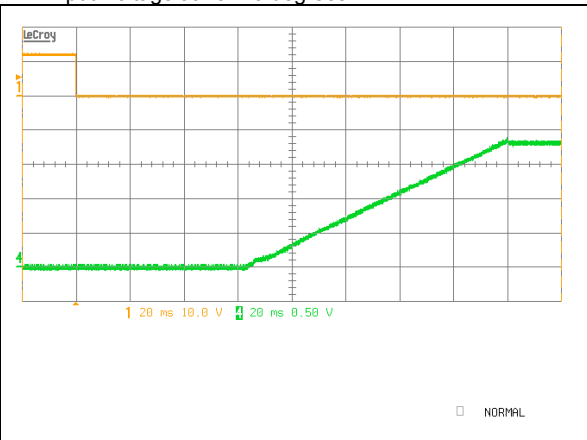

iEA48025A018V-001 Typical startup characteristic from on/off at full load. Ch1 - on/off signal, Ch 4 – output voltage

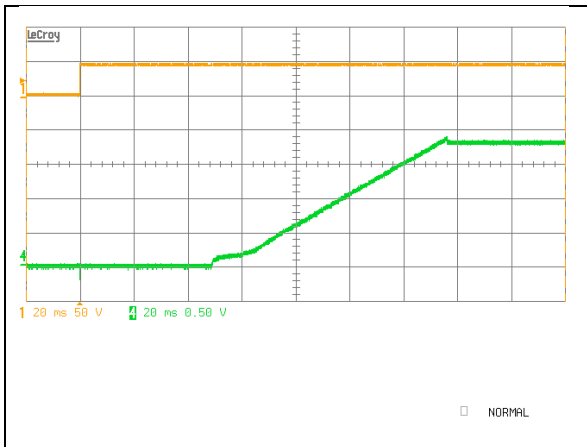

iEA48025A018V-000 Typical startup characteristic from input voltage application at full load. Ch1 - input voltage, Ch 4 – output voltage

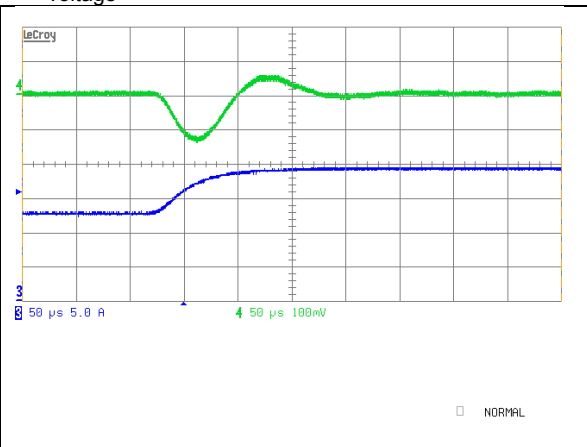

iEA48025A018V-000 Typical transient response. Output voltage response to load step from 50% to 75% of full load with output current slew rate of 0.1A/ μ S.

Electrical Characteristics (continued):
iEA48025A018V-000 through -015: 1.8V, 25A Output

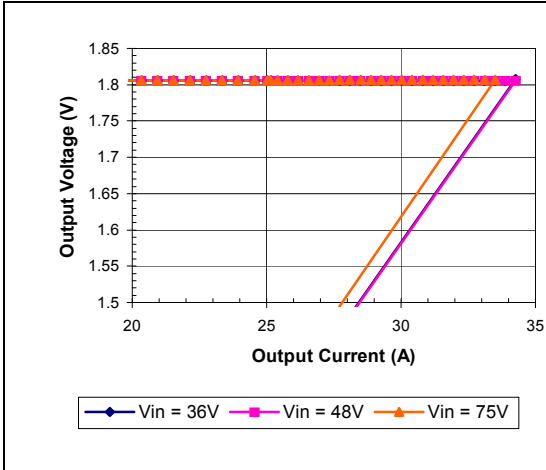

iEA48025A018V-000 Typical Output Current Limit Characteristics vs. Input Voltage at Ta=25 degrees.

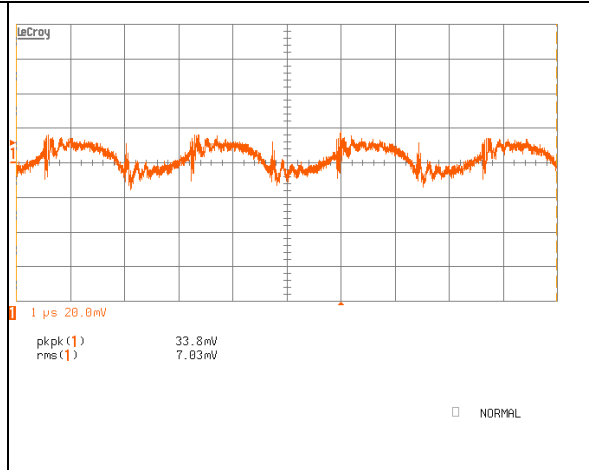

iEA48025A018V-000 Typical Output Ripple at nominal input voltage and full load at Ta=25 degrees

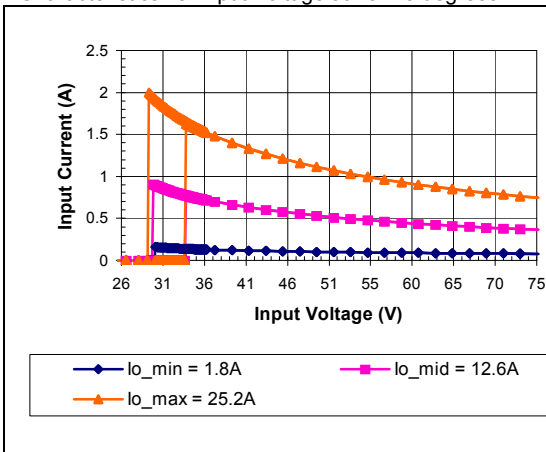

iEA48025A018V-000 Typical Input Current vs. Input Voltage Characteristics

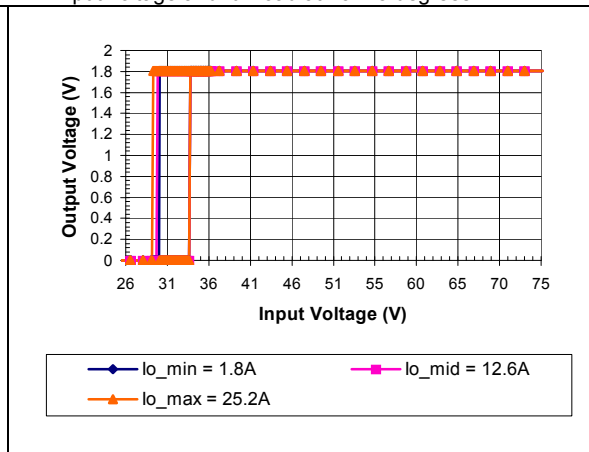

iEA48025A018V-000 Typical Output Voltage vs. Input Voltage Characteristics

% Change of Vout	Trim Down Resistor (Kohm)	% Change of Vout	Trim Up Resistor (Kohm)
-5%	91.8K	+5%	45.2K
-10%	40.8K	+10%	21.2K

e.g. trim up 5%

$$R_{up} := \left[\frac{5.1 \times 1.8 \cdot (100 + 5)}{1.225 \times 5} - \frac{510}{5} - 10.2 \right] \cdot K$$

iEA48025A018V-000 Calculated resistor values for output voltage adjustment

Thermal Performance:

iEA48025A018V-000 through -015: 1.8V, 25A Output

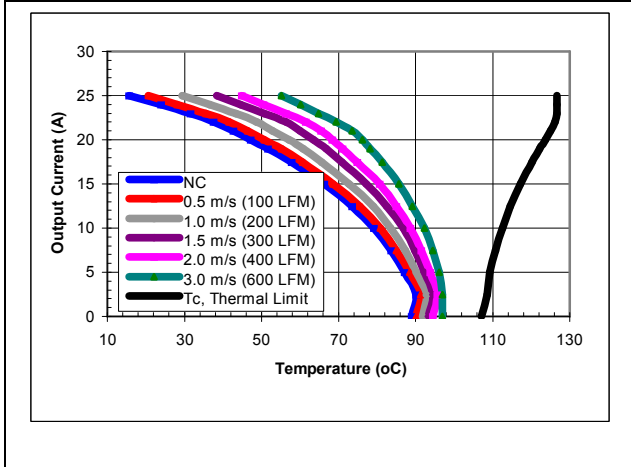

iEA48025A018V-000 maximum output current vs. ambient temperature at nominal input voltage for airflow rates natural convection (60lfm) to 600lfm with airflow from pin 3 to pin 1.

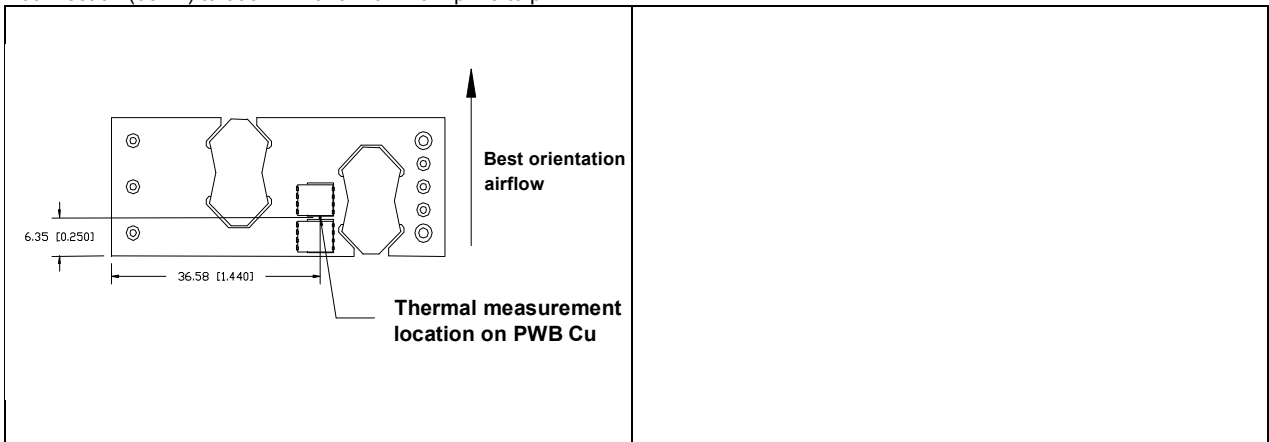

iEA48025A018V-000 thermal measurement location – top view

Both the thermal curves provided and the example given above are based upon measurements made in TDK Innoveta's experimental test setup that is described in the Thermal Management section. Due to the large number of variables in system design, TDK Innoveta recommends that the user verify the module's thermal performance in the end application. The critical component should be thermo coupled and monitored, and should not exceed the temperature limit specified in the derating curve above. It is critical that the thermocouple be mounted in a manner that gives direct thermal contact or significant measurement errors may result. TDK Innoveta can provide modules with a thermocouple pre-mounted to the critical component for system verification tests.

Data Sheet: Belleta[®] iEA Series –Single Output Eighth Brick

Electrical Data:

iEA48025A015V-000 through -015: 1.5V, 25A Output

Characteristic	Min	Typ	Max	Unit	Notes & Conditions
Output Voltage Initial Setpoint	1.47	1.5	1.53	Vdc	Vin=Vin,nom; Io=Io,max; Tc = 25°C
Output Voltage Tolerance	1.45	1.5	1.55	Vdc	Over all rated input voltage, load, and temperature conditions to end of life
Efficiency	---	81	---	%	Vin=Vin,nom; Io=Io,max; Tc = 25°C
Line Regulation	---	1	5	mV	Vin=Vin,min to Vin,max
Load Regulation	---	1	7	mV	Io=Io,min to Io,max
Temperature Regulation	---	10	50	mV	Tc=Tc,min to Tc,max
Output Current	2.0	---	25	A	At loads less than Io,min the module will continue to regulate the output voltage, but the output ripple may increase
Output Current Limiting Threshold	---	35	---	A	Vo = 0.9*Vo,nom, Tc<Tc,max
Short Circuit Current	---	20	---	A	Vo = 0.25V, Tc = 25°C
Output Ripple and Noise Voltage	---	30	100	mVpp	Measured across one 1.0 uF ceramic capacitor and a 10uF tantalum capacitor – see input/output ripple measurement figure; BW = 20MHz
	---	8	---	mVrms	
Output Voltage Adjustment Range	90	---	110	%Vo,nom	
Output Voltage Sense Range	---	---	10	%Vo,nom	
Dynamic Response: Recovery Time	---	120	---	uS	di/dt = 0.1A/uS, Vin=Vin,nom; load step from 50% to 75% of Io,max
Transient Voltage	---	85	---	mV	
Output Voltage Overshoot during startup	---	---	140	mV	Vin=Vin,nom; Io=Io,max, Tc=25°C
Switching Frequency	---	400	---	KHz	Fixed
Output Over Voltage Protection	1.7	---	2.3	V	
External Load Capacitance	0	---	5000	uF	
Isolation Capacitance	---	1000	---	pF	
Isolation Resistance	10	---	---	MΩ	
Vref		1.225		V	Required for trim calculation

& Contact TDK Innoveta for applications that require additional capacitance or very low esr

Electrical Characteristics:
iEA48025A015V-000 through -015: 1.5V, 25A Output

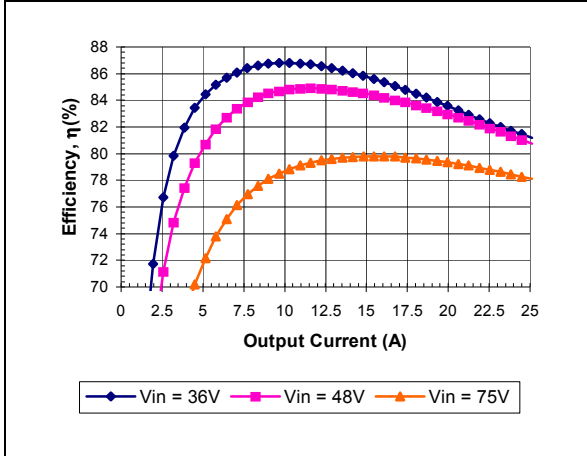

iEA48025A015V-000 Typical Efficiency vs. Input Voltage at Ta=25 degrees.

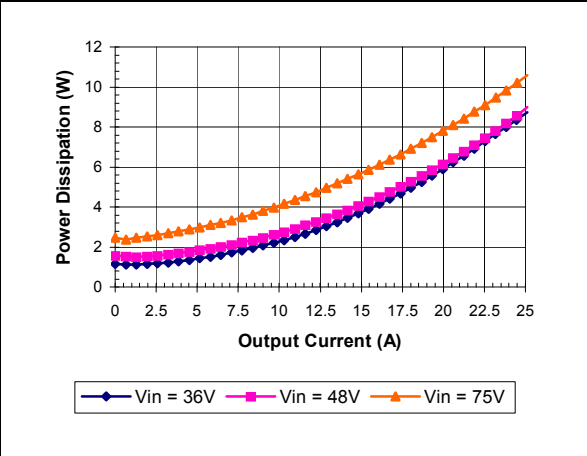

iEA48025A015V-000 Typical Power Dissipation vs. Input Voltage at Ta=25 degrees

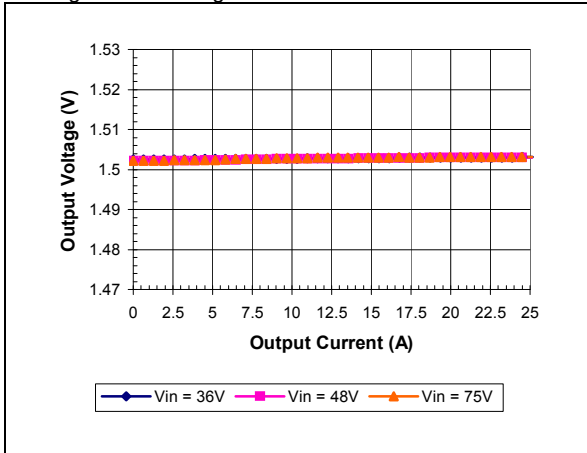

iEA48025A015V-000 Typical Output Voltage vs. Load Current at Ta = 25 degrees

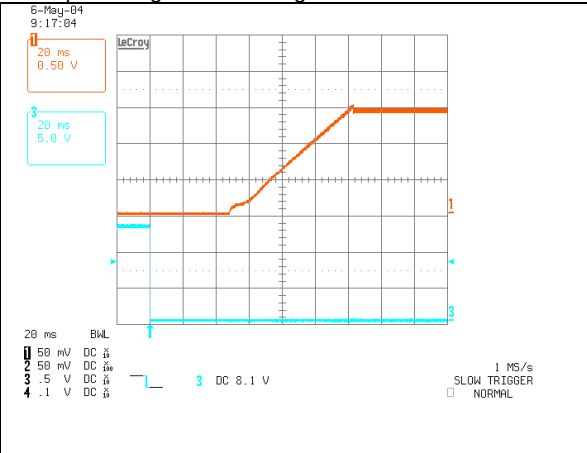

iEA48025A015V-001 Typical startup characteristic from on/off at full load. Ch3 - on/off signal, Ch 1 – output voltage

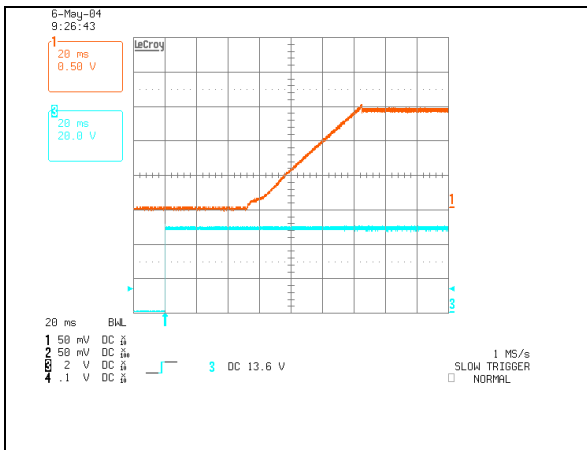

iEA48025A015V-000 Typical startup characteristic from input voltage application at full load. Ch3 - input voltage, Ch 1 – output voltage

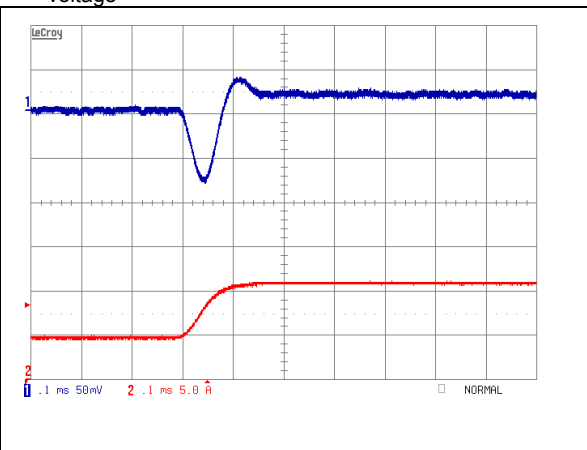

iEA48025A015V-000 Typical transient response. Output voltage response to load step from 50% to 75% of full load with output current slew rate of 0.1A/uS.

Electrical Characteristics (continued):
iEA48025A015V-000 through -015: 1.5V, 25A Output

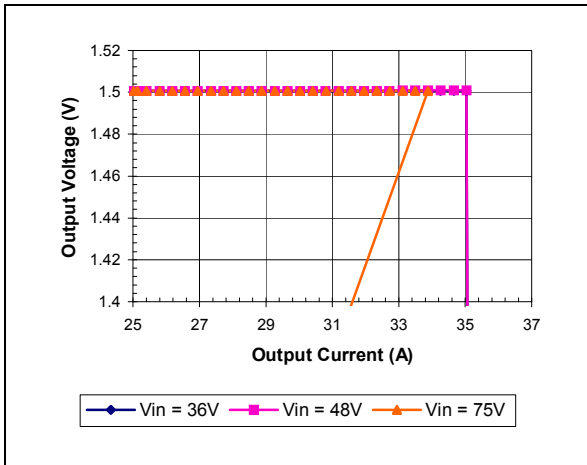

iEA48025A015V-000 Typical Output Current Limit Characteristics vs. Input Voltage at Ta=25 degrees.

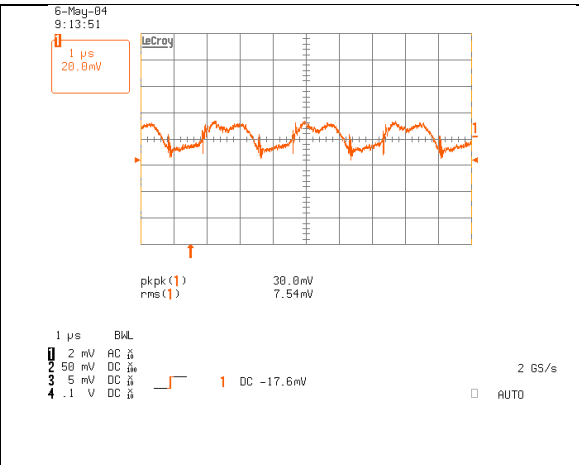

iEA48025A015V-000 Typical Output Ripple at nominal input voltage and full load at Ta=25 degrees

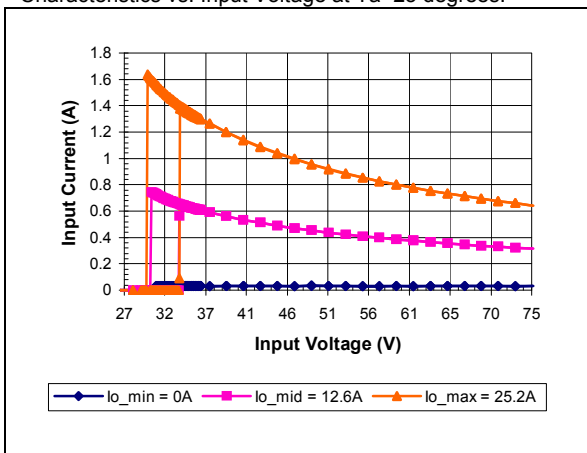

iEA48025A015V-000 Typical Input Current vs. Input Voltage Characteristics

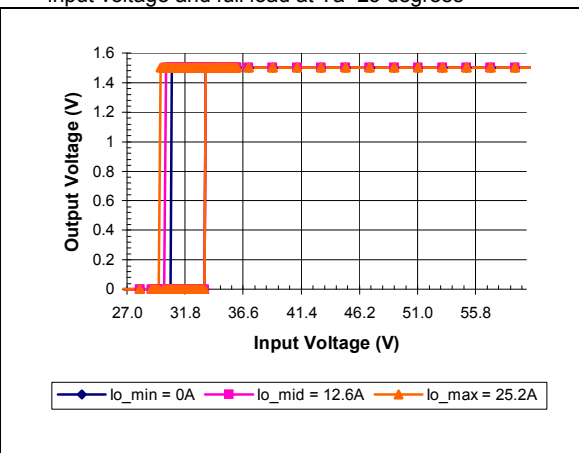

iEA48025A015V-000 Typical Output Voltage vs. Input Voltage Characteristics

% Change of Vout	Trim Down Resistor (Kohm)	% Change of Vout	Trim Up Resistor (Kohm)
-5%	91.8K	+5%	18.9K
-10%	40.8K	+10%	7.5K

e.g. trim up 5%

$$R_{up} := \left[\frac{5.1 \times 1.5 \cdot (100 + 5)}{1.225 \times 5} - \frac{510}{5} - 10.2 \right] \cdot K$$

iEA48025A015V-000 Calculated resistor values for output voltage adjustment

Thermal Performance:

iEA48025A015V-000 through -015: 1.5V, 25A Output

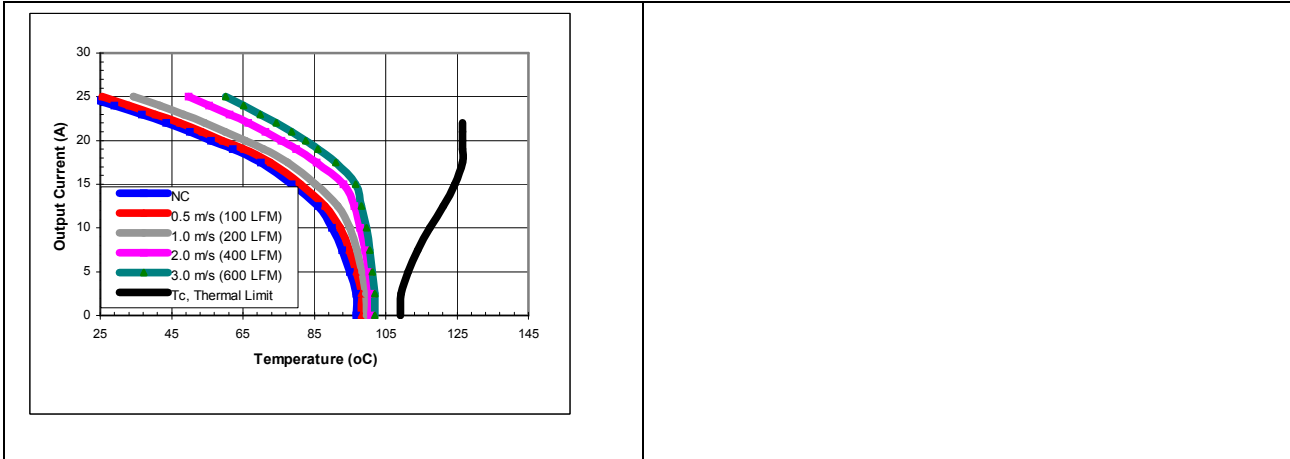

iEA48025A015V-000 maximum output current vs. ambient temperature at nominal input voltage for airflow rates natural convection (60lfm) to 600lfm with airflow from pin 3 to pin 1.

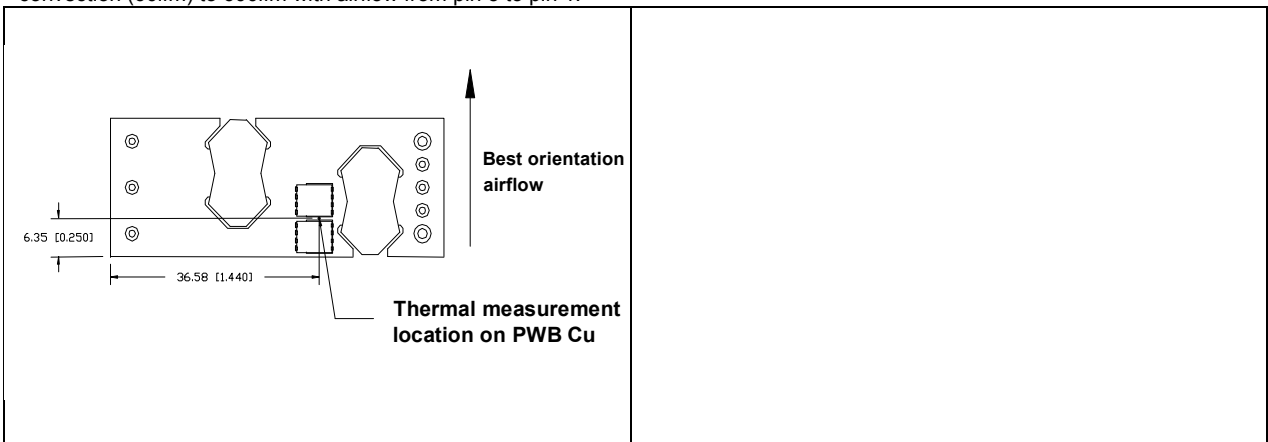

iEA48025A015V-000 thermal measurement location – top view

Both the thermal curves provided and the example given above are based upon measurements made in TDK Innoveta's experimental test setup that is described in the Thermal Management section. Due to the large number of variables in system design, TDK Innoveta recommends that the user verify the module's thermal performance in the end application. The critical component should be thermo coupled and monitored, and should not exceed the temperature limit specified in the derating curve above. It is critical that the thermocouple be mounted in a manner that gives direct thermal contact or significant measurement errors may result. TDK Innoveta can provide modules with a thermocouple pre-mounted to the critical component for system verification tests.

Electrical Data:

iEA48025A012V-000 through -015: 1.2V, 25A Output

Characteristic	Min	Typ	Max	Unit	Notes & Conditions
Output Voltage Initial Setpoint	1.182	1.2	1.218	Vdc	Vin=Vin,nom; Io=Io,max; Tc = 25°C
Output Voltage Tolerance	1.164	1.2	1.236	Vdc	Over all rated input voltage, load, and temperature conditions to end of life
Efficiency	---	78	---	%	Vin=Vin,nom; Io=Io,max; Tc = 25°C
Line Regulation	---	1	5	mV	Vin=Vin,min to Vin,max
Load Regulation	---	1	7	mV	Io=Io,min to Io,max
Temperature Regulation	---	10	50	mV	Tc=Tc,min to Tc,max
Output Current	2.5	---	25	A	At loads less than Io,min the module will continue to regulate the output voltage, but the output ripple may increase
Output Current Limiting Threshold	---	33	---	A	Vo = 0.9*Vo,nom, Tc<Tc,max
Short Circuit Current	---	20	---	A	Vo = 0.25V, Tc = 25°C
Output Ripple and Noise Voltage	---	45	100	mVpp	Measured across one 1.0 uF ceramic capacitor and a 10uF tantalum capacitor – see input/output ripple measurement figure; BW = 20MHz
	---	10	---	mVrms	
Output Voltage Adjustment Range	90	---	110	%Vo,nom	
Output Voltage Sense Range	---	---	10	%Vo,nom	
Dynamic Response: Recovery Time	---	175	---	uS	di/dt = 0.1A/uS, Vin=Vin,nom; load step from 50% to 75% of Io,max
Transient Voltage	---	100	---	mV	
Output Voltage Overshoot during startup	---	---	125	mV	Vin=Vin,nom; Io=Io,max, Tc=25°C
Switching Frequency	---	300	---	kHz	Fixed
Output Over Voltage Protection	1.5	---	2.0	V	
External Load Capacitance	0	---	5000	uF	
Isolation Capacitance	---	1000	---	pF	
Isolation Resistance	10	---	---	MΩ	
Vref		1.225		V	Required for trim calculation

& Contact TDK Innoveta for applications that require additional capacitance or very low esr

Electrical Characteristics: iEA48025A012V-000 through -015: 1.2V, 25A Output

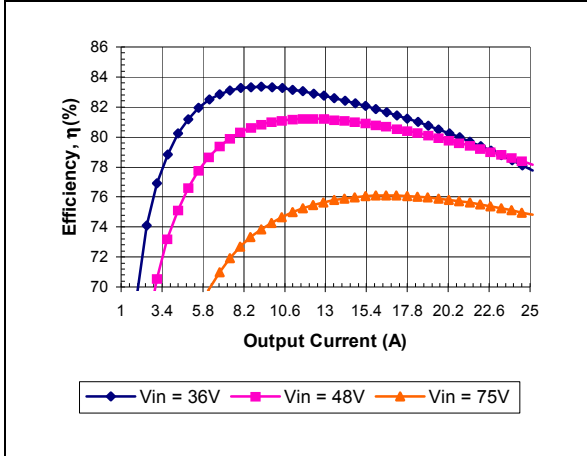

iEA48025A012V-000 Typical Efficiency vs. Input Voltage at Ta=25 degrees.

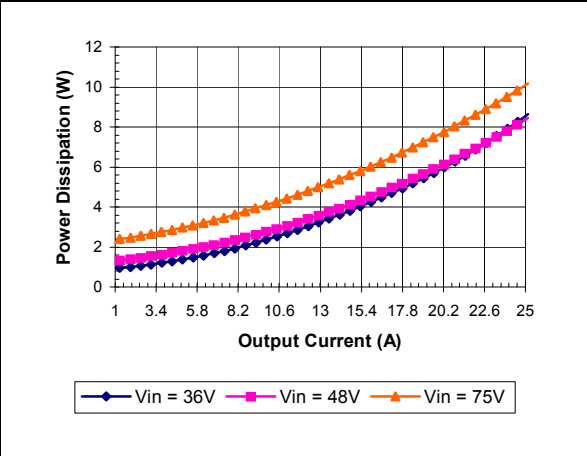

iEA48025A012V-000 Typical Power Dissipation vs. Input Voltage at Ta=25 degrees

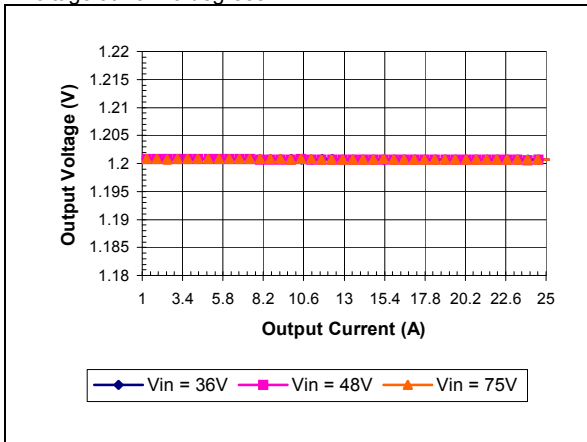

iEA48025A012V-000 Typical Output Voltage vs. Load Current at Ta = 25 degrees

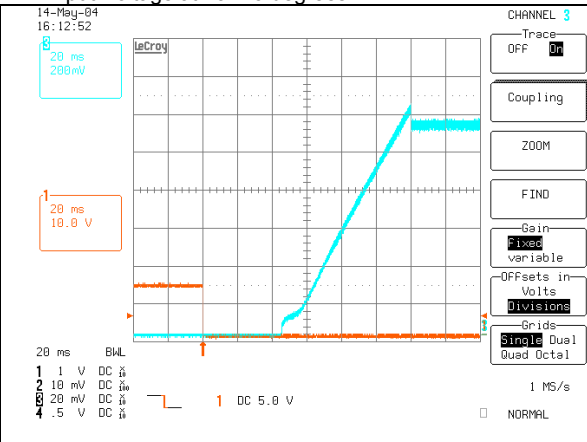

iEA48025A012V-001 Typical startup characteristic from on/off at full load. Ch1-on/off signal, Ch3 –output voltage

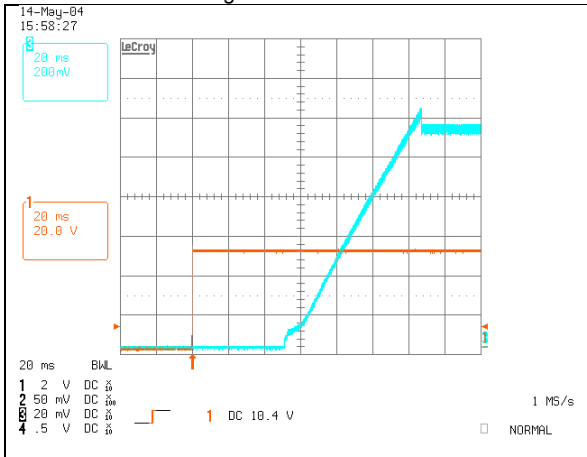

iEA48025A012V-000 Typical startup characteristic from input voltage application at full load. Ch1 - input voltage, Ch3 – output voltage

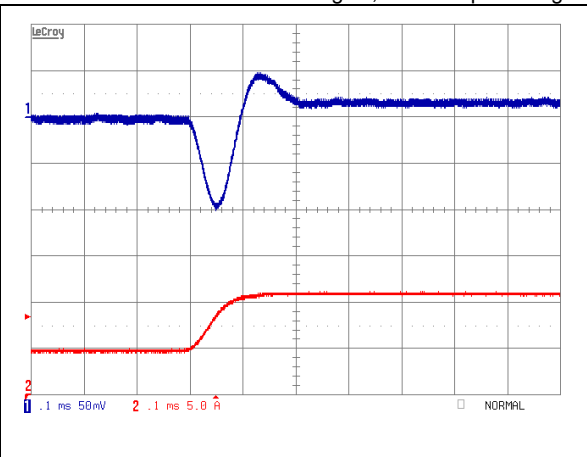

iEA48025A012V-000 Typical transient response. Output voltage response to load step from 50% to 75% of full load with output current slew rate of 0.1A/μS.

Electrical Characteristics (continued):
iEA48025A012V-000 through -015: 1.2V, 25A Output

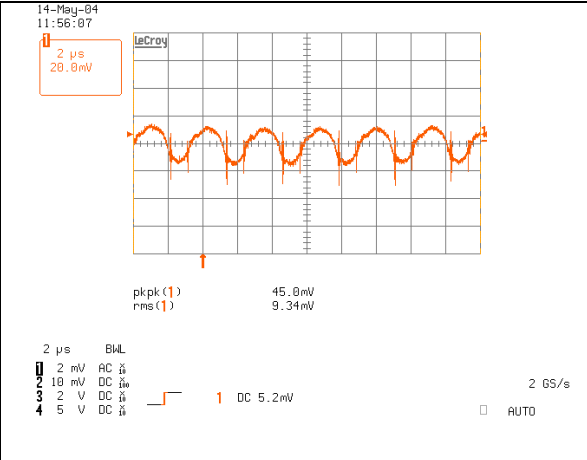
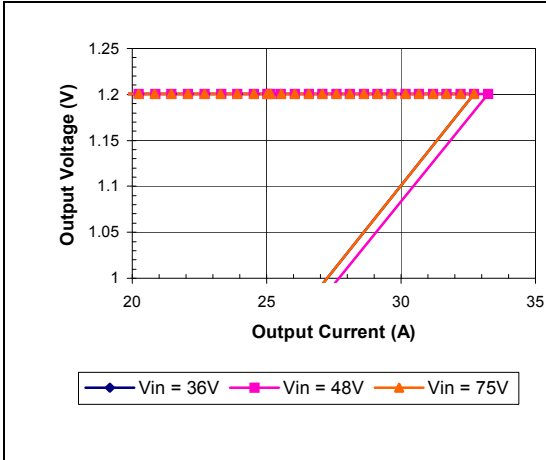

iEA48025A012V-000 Typical Output Current Limit Characteristics vs. Input Voltage at Ta=25 degrees.

iEA48025A012V-000 Typical Output Ripple at nominal input voltage and full load at Ta=25 degrees

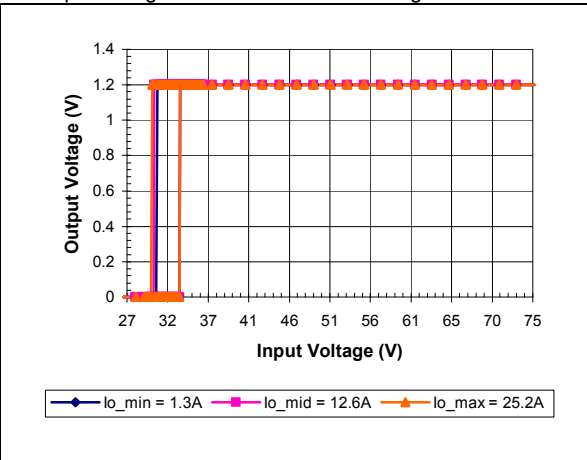
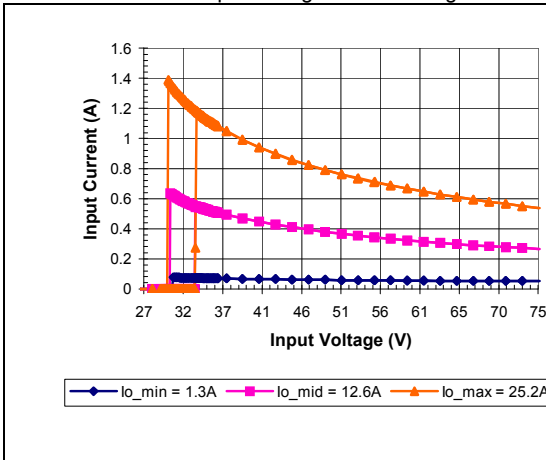

iEA48025A012V-000 Typical Input Current vs. Input Voltage Characteristics

iEA48025A012V-000 Typical Output Voltage vs. Input Voltage Characteristics

% Change of Vout	Trim Down Resistor (Kohm)	% Change of Vout	Trim Up Resistor (Kohm)
-5%	18K	+5%	20K
-10%	8K	+10%	10K

e.g. trim up 5%

$$R_{up} := \left(\frac{100}{5} \right) \cdot K$$

iEA48025A012V-000 Calculated resistor values for output voltage adjustment

Thermal Performance:

iEA48025A012V-000 through -015: 1.2V, 25A Output

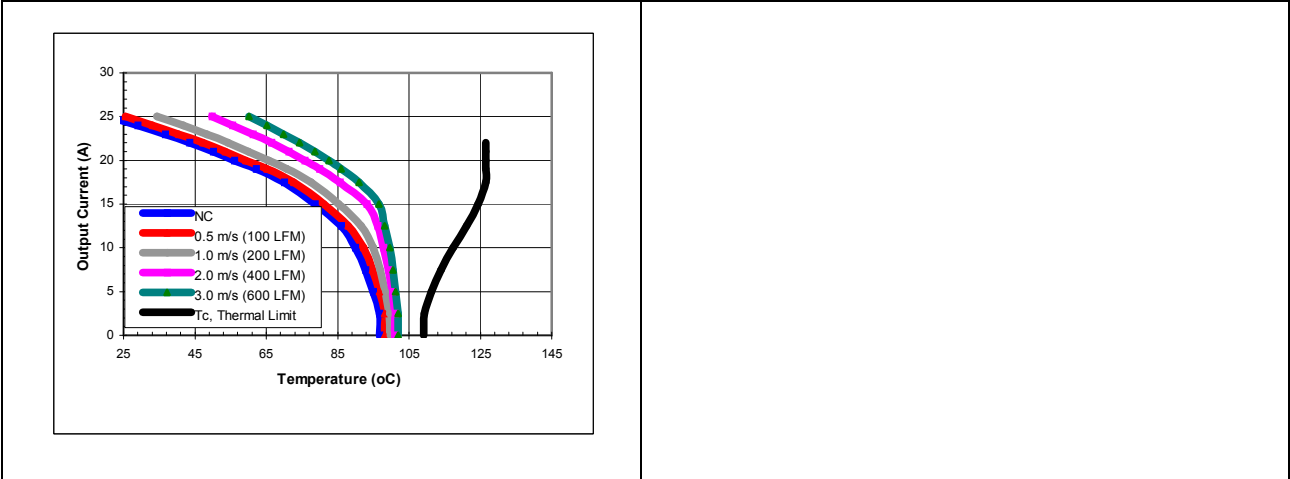

iEA48025A012V-000 maximum output current vs. ambient temperature at nominal input voltage for airflow rates natural convection (60lfm) to 600lfm with airflow from pin 3 to pin 1.

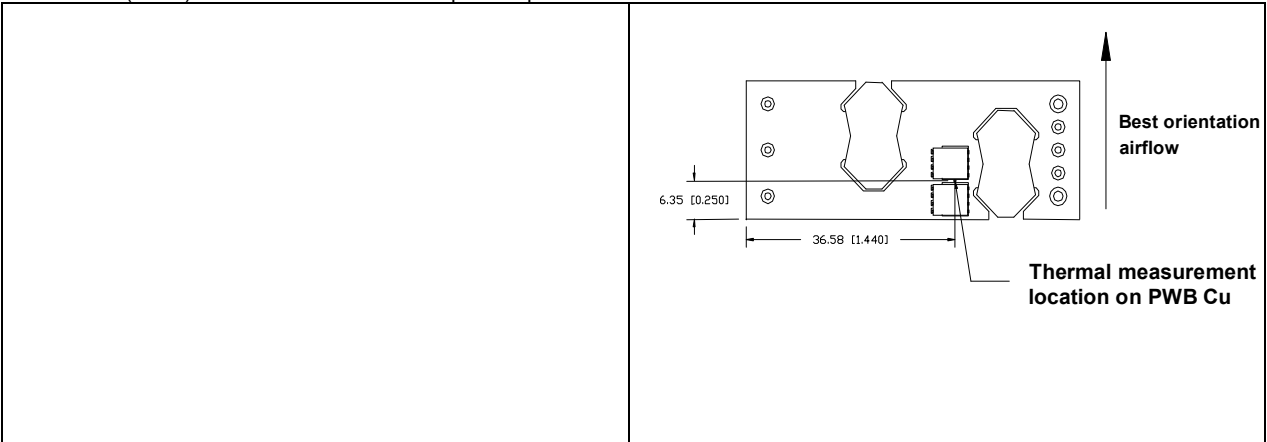

iEA48025A012V-000 thermal measurement location – top view

Both the thermal curves provided and the example given above are based upon measurements made in TDK Innoveta's experimental test setup that is described in the Thermal Management section. Due to the large number of variables in system design, TDK Innoveta recommends that the user verify the module's thermal performance in the end application. The critical component should be thermo coupled and monitored, and should not exceed the temperature limit specified in the derating curve above. It is critical that the thermocouple be mounted in a manner that gives direct thermal contact or significant measurement errors may result. TDK Innoveta can provide modules with a thermocouple pre-mounted to the critical component for system verification tests.

Thermal Management:

An important part of the overall system design process is thermal management; thermal design must be considered at all levels to ensure good reliability and lifetime of the final system. Superior thermal design and the ability to operate in severe application environments are key elements of a robust, reliable power module.

A finite amount of heat must be dissipated from the power module to the surrounding environment. This heat is transferred by the three modes of heat transfer: convection, conduction and radiation. While all three modes of heat transfer are present in every application, convection is the dominant mode of heat transfer in most applications. However, to ensure adequate cooling and proper operation, all three modes should be considered in a final system configuration.

The open frame design of the power module provides an air path to individual components. This air path improves convection cooling to the surrounding environment, which reduces areas of heat concentration and resulting hot spots.

Test Setup: The thermal performance data of the power module is based upon measurements obtained from a wind tunnel test with the setup shown in the wind tunnel figure. This thermal test setup replicates the typical thermal environments encountered in most modern electronic systems with distributed power architectures. The electronic equipment in networking, telecom, wireless, and advanced computer systems operates in similar environments and utilizes vertically mounted PCBs or circuit cards in cabinet racks.

The power module, as shown in the figure, is mounted on a printed circuit board (PCB) and is vertically oriented within the wind tunnel. The cross section of the airflow passage is rectangular. The spacing between the top of the module and a parallel facing PCB is kept at a constant (0.5 in). The power module's orientation with respect

to the airflow direction can have a significant impact on the module's thermal performance.

Thermal Derating: For proper application of the power module in a given thermal environment, output current derating curves are provided as a design

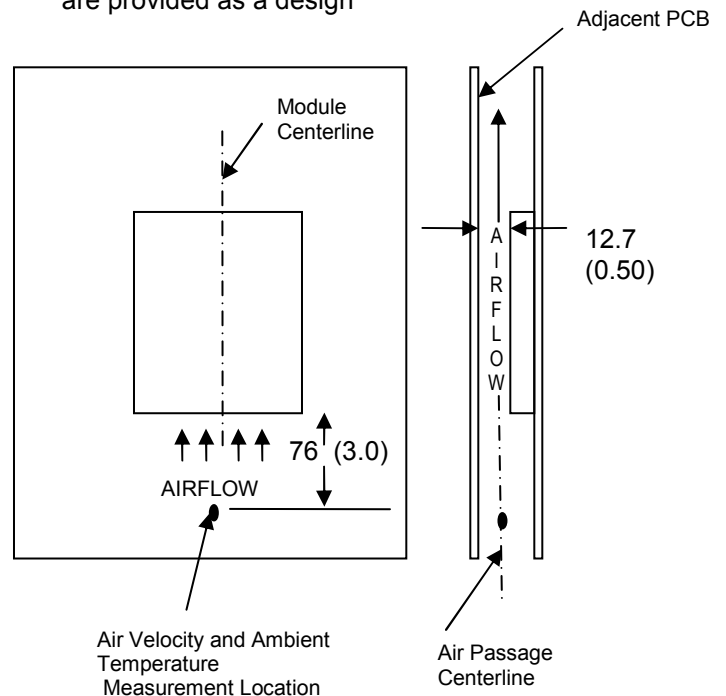

Wind Tunnel Test Setup Figure Dimensions are in millimeters and (inches).

guideline on the Thermal Performance section for the power module of interest. The module temperature should be measured in the final system configuration to ensure proper thermal management of the power module. For thermal performance verification, the module temperature should be measured at the component indicated in the thermal measurement location figure on the thermal performance page for the power module of interest. In all conditions, the power module should be operated below the maximum operating temperature shown on the derating curve. For improved design margins and enhanced system reliability, the power module may be operated at temperatures below the maximum rated operating temperature.

Heat transfer by convection can be enhanced by increasing the airflow rate that the power module experiences. The maximum output current of the power module is a function of ambient temperature (T_{AMB}) and airflow rate as shown in the thermal performance figures on the thermal performance page for the power module of interest. The curves in the figures are shown for natural convection through 2 m/s (400 ft/min). The data for the natural convection condition has been collected at 0.3 m/s (60 ft/min) of airflow, which is the typical airflow generated by other heat dissipating components in many of the systems that these types of modules are used in. In the final system configurations, the airflow rate for the natural convection condition can vary due to temperature gradients from other heat dissipating components.

Operating Information:

Over-Current Protection: The power modules have current limit protection to protect the module during output overload and short circuit conditions. During overload conditions, the power modules may protect themselves by entering a hiccup current limit mode. The modules will operate normally once the output current returns to the specified operating range. There is a typical delay of 30mS from the time an overload condition appears at the module output until the hiccup mode will occur.

Output Over-Voltage Protection: The power modules have a control circuit, independent of the primary control loop that reduces the risk of over voltage appearing at the output of the power module during a fault condition. If there is a fault in the primary regulation loop, the over voltage protection circuitry will cause the power module to enter a hiccup over-voltage mode once it detects that the output voltage has reached the level indicated on the Electrical Data section for the power module of interest. When the condition causing the over-voltage is corrected, the module will operate normally.

An optional latching over-voltage protection is available. On modules with this feature, the power module will shut down once it detects that the output voltage has reached the level indicated on the Electrical Data section for the power module of interest. The module remains off unless the input voltage is recycled.

Thermal Protection: When the power modules exceed the maximum operating temperature, the modules may turn off to safeguard the power unit against thermal damage. The module will auto restart as the unit is cooled below the over temperature threshold. On modules with the latching over-voltage protection feature, the unit may latch off during a severe over temperature condition; the module remains off unless the input voltage is recycled.

Remote On/Off: - The power modules have an internal remote on/off circuit. The user must supply an open-collector or compatible switch between the $V_{in(-)}$ pin and the on/off pin. The maximum voltage generated by the power module at the on/off terminal is 15V. The maximum allowable leakage current of the switch is 50uA. The switch must be capable of maintaining a low signal $V_{on/off} < 1.2V$ while sinking 1mA.

The standard on/off logic is positive logic. The power module will turn on if terminal 2 is left open and will be off if terminal 2 is connected to terminal 3. If the positive logic circuit is not being used, terminal 2 should be left open.

An optional negative logic is available. The power module will turn on if terminal 2 is connected to terminal 3, and it will be off if terminal 2 is left open. If the negative logic feature is not being used, terminal 2 should be shorted to terminal 3.

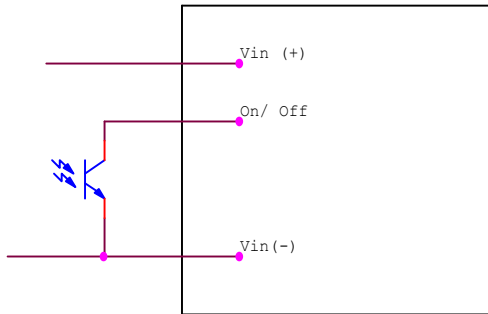

On/Off Circuit for positive or negative logic

Output Voltage Adjustment: The output voltage of the power module may be adjusted by using an external resistor connected between the Vout trim terminal (pin 6) and either the Sense (+) or Sense (-) terminal. If the output voltage adjustment feature is not used, pin 6 should be left open. Care should be taken to avoid injecting noise into the power module’s trim pin. A small 0.01uF capacitor between the power module’s trim pin and Sense (-) pin may help avoid this.

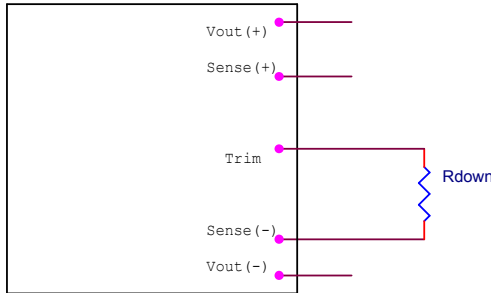

Circuit to decrease output voltage

With a resistor between the trim and Sense (-) terminals, the output voltage is adjusted down. To adjust the output voltage down a percentage of Vout (%Vo) from Vo,nom, the trim resistor should be chosen according to the following equation:

For all outputs except 1.2V:

$$R_{down} := \left(\frac{510}{\%V_o} - 10.2 \right) \cdot 1000$$

For 1.2V output only:

$$R_{down} := \left(\frac{100}{\%V_o} - 2 \right) \cdot 1000$$

The current limit set point does not increase as the module is trimmed down, so the available output power is reduced.

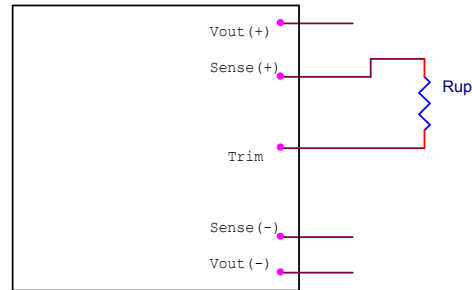

Circuit to increase output voltage

With a resistor between the trim and sense (+) terminals, the output voltage is adjusted up. To adjust the output voltage up a percentage of Vout (%Vo) from Vo,nom the trim resistor should be chosen according to the following equation:

For all outputs except 1.2V:

$$R_{up} := \left[\frac{5.1V_{onom} \cdot (100 + \%V_o)}{V_{ref} \%V_o} - \frac{510}{\%V_o} - 10.2 \right] \cdot 1000$$

For 1.2V output only:

$$R_{up} := \left(\frac{100}{\%V_o} \right) \cdot 1000$$

The value of Vref is found in the Electrical Data section for the power module of interest. The maximum power available from the power module is fixed. As the output voltage is trimmed up, the maximum output current must be decreased to maintain the maximum rated power of the module. As the output voltage is trimmed, the output over-voltage set point is not adjusted. Trimming the output voltage too high may cause the output over voltage protection circuit to be triggered.

Remote Sense: The power modules feature remote sense to compensate for the effect of output distribution drops. The output voltage sense range defines the maximum voltage allowed between the output power terminals and output sense terminals, and it is found on the electrical data page for the power module of interest. If the remote sense feature is not being used, the Sense(+) terminal should be connected to the Vo(+) terminal and the Sense (-) terminal should be connected to the Vo(-) terminal.

The output voltage at the Vo(+) and Vo(-) terminals can be increased by either the remote sense or the output voltage adjustment feature. The maximum voltage increase allowed is the larger of the remote sense range or the output voltage adjustment range; it is not the sum of both.

As the output voltage increases due to the use of the remote sense, the maximum output current must be decreased for the power module to remain below its maximum power rating.

EMC Considerations: TDK Innoveta power modules are designed for use in a wide variety of systems and applications. For assistance with designing for EMC compliance, please contact TDK Innoveta technical support.

Input Impedance:

The source impedance of the power feeding the DC/DC converter module will interact with the DC/DC converter. To minimize the interaction, a 10-100uF input electrolytic capacitor should be present if the source inductance is greater than 1.5uH.

Reliability:

The power modules are designed using TDK Innoveta's stringent design guidelines for component derating, product qualification, and design reviews. Early failures are screened out by both burn-in and an automated final test. The MTBF is calculated to be greater than 4.8M hours at full output power and $T_a = 40^{\circ}\text{C}$ using the Telcordia SR-332 calculation method.

Improper handling or cleaning processes can adversely affect the appearance, testability, and reliability of the power modules. Contact TDK Innoveta technical support for guidance regarding proper handling, cleaning, and soldering of TDK Innoveta's power modules.

Quality:

TDK Innoveta's product development process incorporates advanced quality planning tools such as FMEA and Cpk analysis to ensure designs are robust and reliable. All products are assembled at ISO certified assembly plants.

Input/Output Ripple and Noise Measurements:

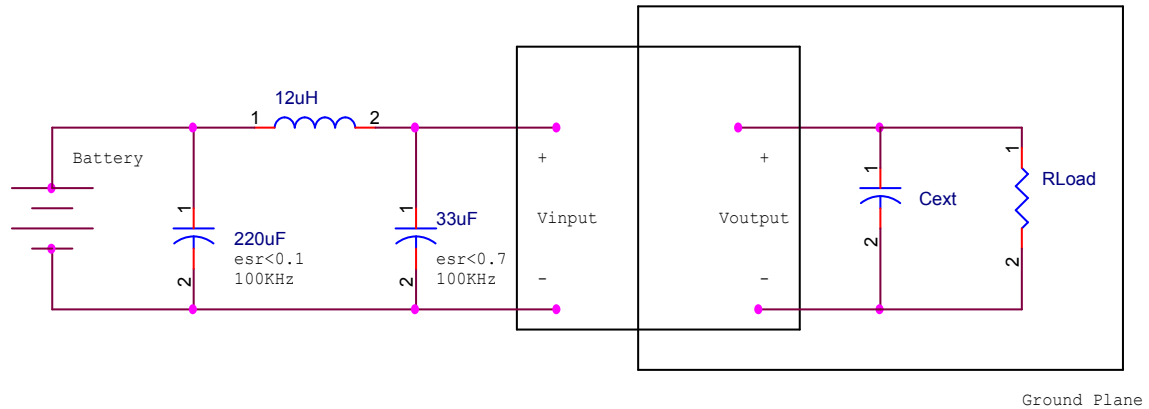

The input reflected ripple is measured with a current probe and oscilloscope. The ripple current is the current through the 12uH inductor.

The output ripple measurement is made approximately 9 cm (3.5 in.) from the power module using an oscilloscope and BNC socket. The capacitor C_{ext} is located about 5 cm (2 in.) from the power module; its value varies from code to code and is found on the electrical data page for the power module of interest under the ripple & noise voltage specification in the Notes & Conditions column.

Safety Considerations:

For safety agency approval of the system in which the DC-DC power module is installed, the power module must be installed in compliance with the creepage and clearance requirements of the safety agency. The isolation is basic insulation. For applications requiring basic insulation, care must be taken to maintain minimum creepage and clearance distances when routing traces near the power module.

As part of the production process, the power modules are hi-pot tested from primary and secondary at a test voltage of 1500Vdc.

To preserve maximum flexibility, the power modules are not internally fused. An external input line normal blow fuse with a maximum value of 10A is required by safety agencies. A lower value fuse can be selected based upon the maximum dc input current and maximum inrush energy of the power module.

When the supply to the DC-DC converter is less than 60Vdc, the power module meets all of the requirements for SELV. If the input voltage is a hazardous voltage that exceeds 60Vdc, the output can be considered SELV only if the following conditions are met:

- 1) The input source is isolated from the ac mains by reinforced insulation.
- 2) The input terminal pins are not accessible.
- 3) One pole of the input and one pole of the output are grounded or both are kept floating.
- 4) Single fault testing is performed on the end system to ensure that under a single fault, hazardous voltages do not appear at the module output.

Warranty:

TDK Innoveta's comprehensive line of power solutions includes efficient, high-density DC-DC converters. TDK Innoveta offers a three-year limited warranty. Complete warranty information is listed on our web site or is available upon request from TDK Innoveta.



Data Sheet: Belleta® iEA Series –Single Output Eighth Brick



3320 Matrix Drive, Suite 100
Richardson, TX 75082

Phone (877) 498-0099 Toll Free
(469) 916.4747

Fax (877) 498-0143 Toll Free
(214) 239.3101

support@tdkinnoveta.com
<http://www.tdkinnoveta.com/>

Information furnished by TDK Innoveta is believed to be accurate and reliable. However, TDK Innoveta assumes no responsibility for its use, nor for any infringement of patents or other rights of third parties, which may result from its use. No license is granted by implication or otherwise under any patent or patent rights of TDK Innoveta. TDK Innoveta components are not designed to be used in applications, such as life support systems, wherein failure or malfunction could result in injury or death. All sales are subject to TDK Innoveta's Terms and Conditions of Sale, which are available upon request. Specifications are subject to change